



BASIC MANUAL

VHF/UHF TRANSCEIVER ID-52A PLUS ID-52E PLUS

This device complies with part 15 of the FCC Rules. Operation is subject to the condition that this device does not cause harmful interference.

WARNING: MODIFICATION OF THIS DEVICE TO RECEIVE CELLULAR RADIOTELEPHONE SERVICE SIGNALS IS PROHIBITED UNDER FCC RULES AND FEDERAL LAW.



Icom Inc.

Thank you for choosing this Icom product. This product is designed and built with Icom's state of the art technology and craftsmanship. With proper care, this product should provide you with years of trouble-free operation.

This product combines traditional analog technologies with Digital Smart Technologies for Amateur Radio (D-STAR), for a balanced package.

■ Important

READ ALL INSTRUCTIONS carefully and completely before using the transceiver.

SAVE THIS INSTRUCTION MANUAL— This instruction manual contains basic operating instructions for the ID-52A PLUS/ID-52E PLUS. For advanced operating instructions, see the Advanced manual for details.

The Advanced manual can be downloaded from the following internet address:

<https://www.icomjapan.com/support/>

■ Features

- D-STAR operation: The ID-52A PLUS/ID-52E PLUS has the D-STAR Repeater (DR) function.
- The Dualwatch function can simultaneously receive and record two different bands or modes.
- A built-in GPS receiver to check your current location.
- The Voice recorder records your QSO conversation, voice audio for TX, and microphone voice audio.
- A microSD card slot that can accept different cards to backup settings, various memories, the GPS log, and so on.
- A USB connector for data transmission or battery charging.
- The Bluetooth® function that can connect to Bluetooth® devices, such as the VS-3.
- The waterfall display of the Band Scope function or Memory Scope function to display signal strengths over time.
- The DV Gateway function can be used with Bluetooth on Android or iOS devices.

■ Explicit definitions

| WORD | DEFINITION |
|-------------------|--|
| ⚠ DANGER! | Personal death, serious injury or an explosion may occur. |
| ⚠ WARNING! | Personal injury, fire hazard or electric shock may occur. |
| CAUTION | Equipment damage may occur. |
| NOTE | Recommended for optimum use. No risk of personal injury, fire or electric shock. |

Icom is not responsible for the destruction, damage to, or performance of any Icom or non-Icom equipment, if the malfunction is because of:

- Force majeure, including, but not limited to, fires, earthquakes, storms, floods, lightning, or other natural disasters, disturbances, riots, war, or radioactive contamination.
- The use of Icom transceivers with any equipment that is not manufactured or approved by Icom.

About weld lines

This product's surfaces may have streaks called "weld lines," that occur during the molding process, and are not cracks or flaws.

■ Supplied accessories



Antenna



Hand strap

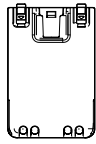

Battery pack

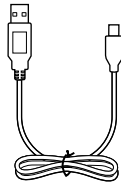

USB cable
(Type-A/Type-C)

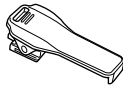

Belt clip

NOTE: Some accessories are not supplied, or the shape is different, depending on the transceiver version.

■ Disposal



The crossed-out wheeled-bin symbol on your product, literature, or packaging reminds you that in the European Union, all electrical and electronic products, batteries, and accumulators (rechargeable batteries) must be taken to designated collection locations at the end of their working life. Do not dispose of these products as unsorted municipal waste. Dispose of them according to the laws in your area.

■ About CE and DOC



Hereby, Icom Inc. declares that the versions of ID-52E PLUS which have the "CE" symbol on the product, comply with the essential requirements of the Radio Equipment Directive, 2014/53/EU, and the restriction of the use of certain hazardous substances in electrical and electronic equipment Directive, 2011/65/EU. The full text of the EU declaration of conformity is available at the following internet address: <https://www.icomjapan.com/support/>

■ About UKCA DOC

To obtain the UKCA Declaration of Conformity, please contact Icom UK Limited by email at info@icomuk.co.uk or alternatively call + 44(0) 1227 741741.

■ FCC information

This equipment has been tested and found to comply with the limits for a Class B digital device, pursuant to part 15 of the FCC Rules. These limits are designed to provide reasonable protection against harmful interference in a residential installation. This equipment generates, uses, and can radiate radio frequency energy and, if not installed and used in accordance with the instructions, may cause harmful interference to radio communications. However, there is no guarantee that interference will not occur in a particular installation. If this equipment does cause harmful interference to radio or television reception, which can be determined by turning the equipment off and on, the user is encouraged to try to correct the interference by one or more of the following measures:

- Reorient or relocate the receiving antenna.
- Increase the separation between the equipment and receiver.
- Connect the equipment into an outlet on a circuit different from that to which the receiver is connected.
- Consult the dealer or an experienced radio/TV technician for help.

CAUTION: Changes or modifications to this device, not expressly approved by Icom Inc., could void your authority to operate this device under FCC regulations.

Internal Bluetooth unit information:

| | |
|---------|-------------|
| FCC ID: | AFJ387300 |
| IC: | 202D-387300 |

For Canada:

This device contains licence-exempt transmitter(s)/receiver(s) that comply with Innovation, Science and Economic Development Canada (ISED)'s licence-exempt RSS(s). Operation is subject to the following two conditions: (1) this device may not cause interference, and (2) this device must accept any interference, including interference that may cause undesired operation of the device.

■ About the ID-52A PLUS/ID-52E PLUS manuals

You can use the following manuals to understand and operate this transceiver.

(As of December 2024)

TIP: You can download each manual and guide from the Icom website:

<https://www.icomjapan.com/support/>

Enter "ID-52A PLUS" or "ID-52E PLUS" into the Search box on the site.

Basic manual (This manual)

Instructions for basic operations and precautions.

Advanced manual (PDF type)

Instructions for the advanced operations, as shown below.

- Using a microSD card
- Battery operation
- FM Radio operation
- D-STAR operation
- GPS operation
- Voice TX operation
- Voice recorder operation
- Memory operation
- Scan operation
- Repeater and duplex operations
- Bluetooth® operation
- Set mode
- Other functions
- Firmware updating
- Options

Updating the repeater list (PDF type)

Instructions for the steps to update the repeater list.

Using the GPS Logger function (PDF type)

Instructions for operating the GPS Logger function, that saves location data from a GPS receiver onto a microSD card as a log.

About the DV Gateway function (PDF type)

Instructions for the system requirements or operations to use the DV Gateway function.

CI-V Reference Guide (PDF type)

Describes the control commands used in remote control operation (serial communication using CI-V).

- ① If necessary, you can see a glossary of HAM radio terms that can be downloaded from the Icom website.
- ① To read the manuals or Guide, Adobe® Acrobat® Reader® is required. If you have not installed it, please download the Adobe® Acrobat® Reader® and install it on your PC. You can download it from Adobe Systems Incorporated's website.

■ Important Notes

◇ When using the GPS receiver

- GPS signals cannot pass through metal objects. When using the transceiver inside a vehicle, you may not receive GPS signals. We recommend you use it near a window.
- The Global Positioning System (GPS) is built and operated by the U.S. Department of Defense. The Department is responsible for accuracy and maintenance of the system. Any changes by the Department may affect the accuracy and function of the GPS system.
- The GPS receiver is installed under the transceiver's top panel. Therefore, when the GPS receiver is activated, do not cover the top with anything that will block the satellite signals.
- The GPS receiver may not work if used in the following locations:
 - Tunnels or high-rise buildings
 - Underground parking lots
 - Under a bridge or viaduct
 - In remote forested areas
 - Under bad weather conditions (rainy or cloudy day)
- The GPS receiver may not work if the transceiver operates near 373.135 MHz or 467.090 MHz on the A band, or 468.000 MHz on the B band. This is due to signals made in the internal circuit, and does not indicate a transceiver malfunction.

The GPS receiver is installed here.

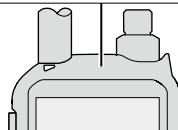

◇ Electromagnetic Interference

When you use a Bluetooth device, pay attention to the following:

Bluetooth devices operate in the 2.4 GHz band. The 2.4 GHz band is also used by other devices, such as Wireless LAN products, microwave ovens, RFID systems, amateur radio stations, and so on. When using the Bluetooth device near such devices, interference may occur, causing a decrease in communication speed, and an unstable connection. In such cases, use this device away from the other devices, or stop using those devices.

① See the Advanced manual for details.

◇ Spurious signals

Using the Dualwatch function, or monitoring the broadcast FM radio band while using the Dualwatch function, may generate certain spurious signals, or noise may be heard, depending on the combination of the operating band and mode. These do not indicate a transceiver malfunction.

◇ About charging with the power ON

When the battery pack is attached, and the optional CP-12L or OPC-254L external DC power cable is connected to [DC IN], the battery pack can be charged even if the transceiver is ON. This operation may generate certain spurious signals, and the S-meter may appear, or noise may be heard.

NOTE:

- The charging time with the power ON may differ, depending on the operating condition.
- The external DC power supply voltage must be between 10 ~ 16 V, and the current capacity must be more than 2.5 A to charge the battery pack with the power ON.
- When you operate the transceiver while charging, and if you cannot receive signals correctly, set "Charging (Power ON)** to "OFF."

* [MENU] > SET > Function > Charging (Power ON) (Default: ON)

■ Unique functions

This section introduces unique functions built into the ID-52A PLUS/ID-52E PLUS.

- ① See the Advanced manual or “About the DV Gateway function” that can be downloaded from the Icom website for more details.

1

DV Gateway function

Even if you cannot access a D-STAR repeater, you can make a direct Gateway call through the Internet.

NOTE:

- A Global IP connection is necessary for your Windows, Android or iOS device.
- Download and install the RS-MS3W, RS-MS3A, or RS-MS3I application software from the Icom website, Google Play, or App Store.
- See “About the DV Gateway function” that can be downloaded from the Icom website for details.

Terminal mode

The Terminal mode enables you to make a direct Gateway call through the Internet using a Windows, Android or iOS device.

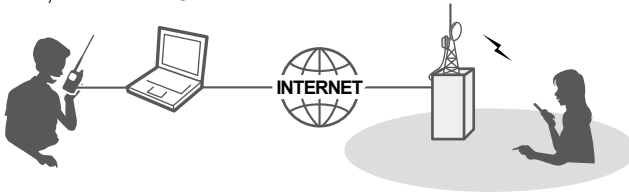

Access Point mode

The Access Point mode enables a D-STAR transceiver to make a Gateway call through an ID-52A PLUS/ID-52E PLUS using a Windows, Android or iOS device.

IMPORTANT: Before you set up an access point, check any regulations or laws in your country.

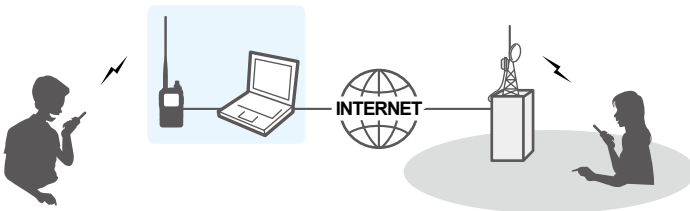

2

Waterfall display

On the single band display, you can confirm the signal strengths over time by the waterfall display. (Advanced manual)

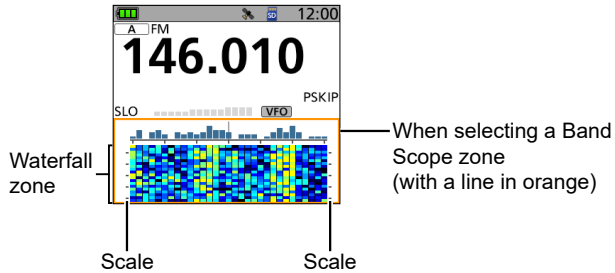

3

Share Pictures function

You can send a picture that is saved onto a microSD card, and view a received picture, even if you do not use the RS-MS1A or the RS-MS11. (Advanced manual)

① To use this function, a microSD card (User supplied) is required.

4

Near Repeater (DV/FM) search function

You can select nearby repeaters using the DR function. The function can find only repeaters that are in your transceiver's repeater list. (Advanced manual)

| NEAR REPEATER (ALL) 1/1 | |
|-------------------------|----------|
| Hirano/Icom | |
| Narayama/Icom | |
| Nagoya UNV | |
| | |
| | |
| 8.0mi | JP3YHH A |

■ Trademarks

Icom and the Icom logo are registered trademarks of Icom Incorporated (Japan) in Japan, the United States, the United Kingdom, Germany, France, Spain, Russia, Australia, New Zealand, and/or other countries.

The Bluetooth® word mark and logos are registered trademarks owned by Bluetooth SIG, Inc. and any use of such marks by Icom Inc. is under license. Other trademarks and trade names are those of their respective owners.

Adobe, Acrobat, and Reader are either registered trademarks or trademarks of Adobe Systems Incorporated in the United States and/or other countries.

Google Play and Android are registered trademarks or trademarks of Google LLC. Windows is a trademark of the Microsoft group of companies.

IOS is a trademark or registered trademark of Cisco in the U.S. and other countries and is used under license.

App Store is a service mark of Apple Inc. AMBE+2 is a trademark and property of Digital Voice Systems Inc.

All other products or brands are registered trademarks or trademarks of their respective holders.

This product includes “zlib” open source software, and is licensed according to the open source software license.

This product includes “libpng” open source software, and is licensed according to the open source software license.

Refer to the “About the Licenses” page at the end of the manual in English for information on the open source software being used in this product.

This software is based in part on the work of the Independent JPEG Group, and is licensed according to the open source software license.

■ Voice Coding Technology

The AMBE+2™ voice coding Technology embodied in this product is protected by intellectual property rights including patent rights, copyrights and trade secrets of Digital Voice Systems, Inc. This voice coding Technology is licensed solely for use within this Communications Equipment.

The user of this Technology is explicitly prohibited from attempting to extract, remove, decompile, reverse engineer, or disassemble the Object Code, or in any other way convert the Object Code into a human-readable form. U.S. Patent Nos.

#8,359,197 and #7,970,606.

■ Precaution

⚠ **DANGER! NEVER** operate the transceiver near unshielded electrical blasting caps or in an explosive atmosphere. This could cause an explosion and death.

⚠ **DANGER! NEVER** use or charge Icom battery packs with non-Icom transceivers or non-Icom chargers. Only Icom battery packs are tested and approved for use with Icom transceivers or charged with Icom chargers. Using third-party or counterfeit battery packs or chargers may cause smoke, fire, or cause the battery to burst.

⚠ **WARNING RF EXPOSURE!** This transceiver emits Radio Frequency (RF) energy. Extreme caution should be observed when operating this transceiver. If you have any questions regarding RF exposure and safety standards, please refer to the Federal Communications Commission Office of Engineering and Technology’s report on Evaluating Compliance with FCC Guidelines for Human Radio Frequency Electromagnetic Fields (OET Bulletin 65).

⚠ **WARNING! NEVER** hold the transceiver so that the antenna is very close to, or touching exposed parts of the body, especially the face or eyes, while transmitting.

⚠ **WARNING! NEVER** operate or touch the transceiver with wet hands. This could cause an electric shock or damage the transceiver.

⚠ **WARNING! NEVER** operate the transceiver with earphones, a headset, or other audio accessories at high volume levels. If you experience a ringing in your ears, reduce the volume or discontinue use.

⚠ **WARNING! NEVER** connect the transceiver to a power source of more than 16 V DC or use reverse polarity. This could cause a fire or damage the transceiver.

CAUTION: DO NOT short the terminals of the battery pack. Shorting may occur if the terminals touch metal objects such as a key, so be careful when placing the battery packs (or the transceiver) in bags, and so on. Carry them so that shorting cannot occur with metal objects. Shorting may damage not only the battery pack but also the transceiver.

CAUTION: DO NOT operate the transceiver unless the flexible antenna, battery pack, and jack cover are securely attached to the transceiver and that the antenna and battery pack are dry before attachment. Exposing the inside of the transceiver to dust or water will result in serious damage to the transceiver. After exposure to water, clean the battery contacts thoroughly with fresh water and dry them completely to remove any water or salt residue.

CAUTION: DO NOT operate the transceiver while driving a vehicle. Safe driving requires your full attention—anything less may result in an accident.

CAUTION: DO NOT use harsh solvents such as benzine or alcohol when cleaning. This could damage the equipment surfaces. If the surface becomes dusty or dirty, wipe it clean with a soft, dry cloth.

CAUTION: DO NOT place or leave the transceiver in direct sunlight or in areas with temperatures below -20°C (-4°F) or above $+60^{\circ}\text{C}$ ($+140^{\circ}\text{F}$).

CAUTION: DO NOT operate the transceiver if it becomes hot after continuously transmitting for long periods of time. This may damage the transceiver.

NEVER place in an insecure place to avoid inadvertent use by unauthorized persons.

DO NOT push PTT unless you actually intend to transmit.

BE CAREFUL! The transceiver meets IPX7* requirements for waterproof protection. However, once the transceiver has been dropped, waterproof protection cannot be guaranteed.

* Only when the BP-271, BP-272, or BP-307 (option), flexible antenna, [MIC/SP] cover, [USB/DC IN] cover, and [microSD] slot cover are attached.

NOTE: When the BP-273 is attached to the transceiver, it meets IPX4 requirements for splash resistance. When it is connected, the transceiver corresponds to IPX4.

Even when the transceiver power is OFF, a slight current still flows in the circuits. Remove the battery pack or batteries from the transceiver when not using it for a long time. Otherwise, the installed battery pack or batteries will become exhausted and will need to be recharged or replaced.

The LCD display may have cosmetic imperfections that appear as small dark or light spots. This is not a malfunction or defect, but a normal characteristic of LCD displays.

Operate the transceiver that complies with your local laws and regulations. Depending on countries and/or regions, transceiver's output power and/or operations on specific frequencies may be restricted to avoid interferences with existing radio stations or services.

■ Battery cautions

◇ Battery caution

Misuse of Li-ion batteries may result in the following hazards: smoke, fire, or the battery may rupture. Misuse can also cause damage to the battery or degradation of battery performance.

△ **DANGER! NEVER** incinerate used battery packs. Internal battery gas may cause an explosion.

△ **DANGER! NEVER** strike or otherwise impact the battery pack. Do not use the battery pack if it has been severely impacted or dropped, or if the pack has been subjected to heavy pressure. Battery pack damage may not be visible on the outside of the case. Even if the surface of the battery does not show cracks or any other damage, the cells inside the battery may rupture or catch fire.

△ **DANGER! NEVER** leave the battery pack in places with temperatures above 60°C (140°F). A High-temperature buildup in the battery cells, such as could occur near fires or stoves, inside a sun-heated vehicle, or in direct sunlight for long periods of time, may cause the battery cells to rupture or catch fire. Excessive temperatures may also degrade the pack's performance or shorten the battery cell's life.

△ **DANGER! NEVER** place battery packs near a fire. Fire or heat may cause them to rupture or explode. Dispose of used battery packs in accordance with local regulations.

△ **DANGER! NEVER** solder the battery terminals, or **NEVER** modify the battery pack. This may cause heat generation, and the battery may burst, emit smoke or catch fire.

△ **DANGER! NEVER** let fluid from inside the battery get in your eyes. This can cause blindness. Rinse your eyes with clean water, without rubbing them, and immediately go to a doctor.

△ **WARNING! NEVER** use deteriorated battery packs. They could cause a fire.

△ **WARNING! NEVER** let fluid from inside the battery cells come in contact with your body. If it does, immediately wash with clean water.

△ **WARNING! NEVER** put the battery pack in a microwave oven, high-pressure container, or in an induction heating cooker. This could cause a fire, overheating, or cause the battery cells to rupture.

CAUTION: DO NOT expose the battery pack to rain, snow, saltwater, or any other liquids. Do not charge or use a wet pack. If the pack gets wet, be sure to wipe it dry cloth before using.

CAUTION: DO NOT use the battery if it emits an abnormal odor, heats up, or is discolored or deformed. If any of these conditions occur, contact your Icom dealer or distributor.

CAUTION: DO NOT use the battery pack out of the specified temperature range -20°C ~ +60°C (-4°F ~ +140°F). Using the pack out of this range will reduce the pack's performance and battery cell life.

CAUTION: DO NOT leave the pack fully charged, completely discharged, or in an excessive temperature environment (above 50°C, 122°F) for an extended period of time. Otherwise, a shorter battery pack life could occur. If the battery pack must be left unused for a long time, it must be detached from the transceiver after discharging. You may use the pack until the remaining capacity is about half, then keep it safely in a cool, dry place in the following temperature range:

-20°C (-4°F) ~ +50°C (+122°F) (within a month).
-20°C (-4°F) ~ +35°C (+95°F)* (within three months).
-20°C (-4°F) ~ +20°C (+68°F) (within a year).

* BP-307: -20°C (-4°F) ~ +40°C (+104°F)

BE SURE to replace the battery pack with a new one approximately five years after manufacturing, even if it still holds a charge. The material inside the battery cells will become weak after a period of time, even with little use. The estimated number of times you can charge the pack is between 300 and 500. Even when the pack appears to be fully charged, the operating time of the transceiver may become short when:

- Approximately five years have passed since the pack was manufactured.
- The pack has been repeatedly charged.

The battery cells may deteriorate and swell due to their characteristics if used in an environment and conditions such as: frequently charged, recharged immediately after full charge, used or saved in a hot place, or charged by methods other than the instructions. If the battery pack swells, it has reached the end of its life due to deterioration. Replace it with a brand new one.

◇ Charging caution

⚠ **DANGER! NEVER** charge the battery pack in areas with extremely high temperatures, such as near fires or stoves, inside a sun-heated vehicle, or in direct sunlight. In such environments, the safety/protection circuit in the pack will activate and stop the charging.

⚠ **DANGER! NEVER** charge the transceiver during a lightning storm. It may result in an electric shock, cause a fire, or damage the transceiver. Always disconnect the power adapter before a storm.

⚠ **WARNING! NEVER** charge or leave the battery in the battery charger beyond the specified time for charging. If the pack is not completely charged by the specified time, stop charging and remove it from the battery charger. Continuing to charge the pack beyond the specified time limit may cause a fire, overheating, or the battery may rupture.

⚠ **WARNING!** Occasionally observe the battery pack condition while charging. If any abnormal condition occurs, discontinue using the battery pack.

CAUTION: DO NOT insert the transceiver with the battery pack attached into the charger if it is wet or soiled. This could corrode the battery charger terminals or damage the charger. The charger is not waterproof.

CAUTION: DO NOT charge the battery pack outside of the specified temperature range: 0°C ~ 40°C (32°F ~ 104°F). Icom recommends charging the pack at 25°C (77°F). The pack may heat up or rupture if charged out of the specified temperature range. Additionally, battery performance or battery life may be reduced.

CAUTION: DO NOT use the battery charger unless the power outlet is easily accessible and near the unit. Remove it from the AC power outlet when not in use.

■ Table of contents

| | | | |
|---|----------|---|-----------|
| ■ Important..... | i | 3 BASIC OPERATION..... | 11 |
| ■ Features..... | i | ■ Receiving..... | 11 |
| ■ Explicit definitions..... | i | ■ Dualwatch operation..... | 11 |
| ■ Supplied accessories..... | ii | ◇ Turning Dualwatch ON or OFF.... | 11 |
| ■ Disposal..... | ii | ◇ MAIN band selection..... | 11 |
| ■ About CE and DOC..... | ii | ■ Monitor function..... | 12 |
| ■ About UKCA DOC..... | ii | ■ Setting a squelch level..... | 12 |
| ■ FCC information..... | ii | ■ Quick Menu window..... | 13 |
| ■ About the ID-52A PLUS/ID-52E PLUS manuals..... | iii | ◇ Quick Menu window operation.... | 13 |
| ■ Important Notes..... | iv | ■ Selecting the Frequency Selecting mode..... | 14 |
| ◇ When using the GPS receiver..... | iv | ◇ VFO mode..... | 14 |
| ◇ Electromagnetic Interference..... | iv | ◇ Memory mode..... | 14 |
| ◇ Spurious signals..... | iv | ◇ Call Channel mode..... | 14 |
| ◇ About charging with the power ON..... | iv | ◇ Weather Channel mode (For only the ID-52A PLUS)..... | 14 |
| ■ Unique functions..... | v | ■ DR function operation..... | 14 |
| ■ Trademarks..... | vii | ■ Selecting the operating band..... | 15 |
| ■ Voice Coding Technology..... | vii | ■ Selecting the operating mode..... | 15 |
| ■ Precaution..... | vii | ■ Setting a frequency..... | 16 |
| ■ Battery cautions..... | ix | ◇ Selecting a tuning step..... | 16 |
| ◇ Battery caution..... | ix | ◇ Selecting the 1 MHz tuning..... | 16 |
| ◇ Charging caution..... | x | ■ Attenuator..... | 16 |
| 1 PANEL DESCRIPTION..... | 1 | ■ Scan operation..... | 17 |
| ■ Front, top, and side panels..... | 1 | ■ Speech function..... | 17 |
| ■ Function display..... | 3 | ■ Home Channel function..... | 18 |
| 2 INITIAL SETUP..... | 5 | ◇ Setting a Home Channel..... | 18 |
| ■ Attaching the Battery pack..... | 5 | ■ Transmitting..... | 18 |
| ■ Charging the battery pack..... | 6 | ◇ Making a simplex call..... | 18 |
| ◇ Capacity of the battery pack..... | 6 | ◇ About the transmit power levels.. | 19 |
| ■ Inserting a microSD card..... | 7 | ■ FM Radio operation..... | 20 |
| ■ Turning ON the transceiver..... | 7 | ◇ Turning ON the FM Radio..... | 20 |
| ■ Adjusting the audio level..... | 7 | ■ Lock function..... | 20 |
| ■ Saving the setting data onto a microSD card..... | 8 | ■ Band Scope/Memory Scope function..... | 20 |
| ◇ Formatting a microSD card..... | 8 | 4 MENU SCREEN..... | 21 |
| ◇ Saving the setting data..... | 9 | ■ Selecting a Menu item..... | 21 |
| ■ Confirming the GPS is receiving signals..... | 10 | ◇ MENU screen operation..... | 21 |
| | | ◇ Selecting a Menu item..... | 22 |
| | | 5 MEMORY OPERATION..... | 23 |
| | | ■ Entering Memory channels..... | 23 |
| | | ■ Selecting a Memory channel..... | 24 |
| | | ■ Viewing the Memory channel contents..... | 24 |

| | | |
|-----------|---|-----------|
| 6 | RECORDING A QSO ONTO A | |
| | microSD CARD | 25 |
| | ■ About the microSD card | 25 |
| | ■ Setting the Record operation | 26 |
| | ■ Recording a QSO audio | 27 |
| | ■ Playing a recorded audio | 27 |
| | ■ Removing the microSD card | 28 |
| | ◇ Removing while the transceiver is OFF | 28 |
| | ◇ Removing while the transceiver is ON | 28 |
| 7 | GPS OPERATION | 29 |
| | ■ Checking your location | 29 |
| | ◇ Displaying Location Data..... | 29 |
| | ■ GPS Logger function..... | 30 |
| | ◇ Turning OFF the GPS Logger function | 30 |
| 8 | Bluetooth® OPERATION | 31 |
| | ■ Turning ON the Bluetooth® function | 31 |
| | ■ Connecting to a Bluetooth® headset | 32 |
| | ■ Disconnecting a Bluetooth® device | 33 |
| | ■ Deleting a Bluetooth® device from the pairing list | 33 |
| 9 | SPECIFICATIONS | 34 |
| | ◇ General | 34 |
| | ◇ Transmitter | 35 |
| | ◇ Receiver | 35 |
| | ◇ Bluetooth | 36 |
| 10 | MAINTENANCE | 37 |
| | ■ Resetting..... | 37 |
| | ◇ Partial Reset | 37 |
| | ■ Troubleshooting | 38 |
| | D-STAR GUIDE | 40 |
| | INDEX | 67 |
| | ABOUT THE LICENSES | 69 |
| | MENU SCREEN ITEMS | 71 |

D-STAR GUIDE

| | |
|---|-----------|
| INTRODUCTION | 41 |
| ■ Unique features of D-STAR..... | 41 |
| ■ What is D-STAR? | 42 |
| ■ About the DR function | 43 |
| ■ Ways to Communicate with the DR function | 43 |
| ■ Enter your call sign (MY) into the transceiver | 45 |
| ■ Register your call sign at a gateway repeater..... | 47 |
| D-STAR OPERATION | 49 |
| ■ Making a Simplex call | 49 |
| ■ Accessing repeaters..... | 51 |
| ■ Receiving | 53 |
| ■ Capturing a call sign..... | 55 |
| ■ Making a Local CQ call | 56 |
| ■ Making a Gateway CQ call..... | 57 |
| ■ Calling an individual station..... | 58 |
| ■ About reflectors | 59 |
| ◇ What is a reflector?..... | 59 |
| ◇ Unlinking a reflector | 59 |
| ◇ Linking to a reflector | 60 |
| ◇ Using a reflector | 61 |
| ◇ Reflector Echo Testing..... | 62 |
| ◇ Requesting repeater information | 62 |
| ■ "FROM" (Access repeater) setting...63 | |
| ■ "TO" (Destination) setting | 64 |
| ■ When receiving no reply..... | 65 |
| ■ Updating the repeater list..... | 66 |

1

PANEL DESCRIPTION

■ Front, top, and side panels

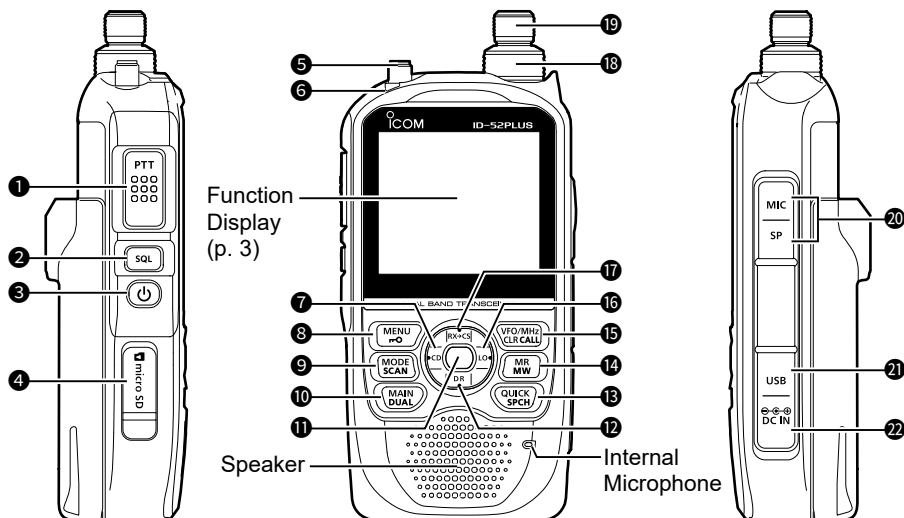

1 PTT SWITCH [PTT]

Hold down to transmit, release to receive.

① For the ID-52E PLUS only

Push briefly and release, and then hold down to transmit a 1750 Hz tone burst.

2 SQUELCH KEY [SQL] (p. 12)

- While holding down, rotate [DIAL] to adjust the squelch level.
- Hold down to temporarily open the squelch and monitor the operating frequency.

3 POWER KEY [P]

- Hold down for 1 second to turn the transceiver ON or OFF. (p. 7)
- When "Screen Capture [PWR] Key" is set to "ON," push to capture the transceiver display onto a microSD card.

([MENU] > SET > Function > Screen Capture [PWR] Key)

4 microSD CARD SLOT [microSD]

Insert a microSD card (User supplied). (p. 7)

5 ANTENNA CONNECTOR

Connect the supplied antenna.

6 TX/RX INDICATOR

- Lights red while transmitting.
- Lights green while receiving a signal, or when the squelch is open.

7 RX CALL SIGN DISPLAY • D-PAD (LEFT) KEY [CD]/D-pad(←)

- In the DV mode, hold down for 1 second to open the received call history. (p. 53)
- In the MENU screen, push to select an upper-tier menu. (p. 21)

8 MENU • LOCK KEY [MENU]/[P-O]

- Push to open the MENU screen. (p. 21)
- Hold down for 1 second to turn the Lock function ON or OFF. (p. 20)

9 MODE • SCAN KEY [MODE]/[SCAN]

- Push to select the operating mode. (p. 15)
- Hold down for 1 second to open the Scan Type Select window. (p. 17)

10 MAIN • DUAL KEY [MAIN]/[DUAL]

- Push to set the A or B band as the MAIN band. (p. 11)
- Hold down for 1 second to turn the Dualwatch function ON or OFF. (p. 11)

- 11 ENTER KEY [ENT]**
Push to set the selected item or option.
- 12 DR • D-PAD (DOWN) KEY [DR]/D-pad(↓)**

 - Hold down for 1 second to turn the DR function ON or OFF. (p. 14)
 - In the DR screen, MENU screen, or Quick Menu window, push to move the option or value selector bar down. (pp. 13, 21, 49)
- 13 QUICK MENU • SPEECH KEY [QUICK]/[SPCH]**

 - Push to open the Quick Menu window. (p. 13)
 - Hold down for 1 second to audibly announce the displayed frequency and operating mode, or call sign. (p. 17)
- 14 MEMORY • SELECT MEMORY WRITE KEY [MR]/[MW]**

 - Push to enter the Memory mode. (p. 14)
 - ① **For the ID-52A PLUS only**
In the Memory mode, push once to enter the Weather Channel mode.
 - Hold down for 1 second to open the Select Memory Write window. (p. 23)
 - Hold down for 3 second to enter the Memory channel contents to a blank channel.
- 15 VFO/MHz • CLEAR • CALL KEY [VFO/MHz]/[CLR]/[CALL]**

 - Push to enter the VFO mode. (p. 16)
 - In the VFO mode, push to select 1 MHz tuning steps. (p. 16)
 - In the MENU screen, push to select an upper-tier menu. (p. 21)
 - Push to delete an entered character. (p. 46)
 - Hold down for 1 second to enter the Call Channel mode. (p. 14)
- 16 LO • D-PAD (RIGHT) KEY [LO]/D-pad(→)**

 - Hold down for 1 second to open the Select Output Power window. (p. 19)
 - In the MENU screen, push to select a lower-tier menu. (p. 21)
- 17 RX CALL SIGN CAPTURE • D-PAD (UP) KEY [RX→CS]/D-pad(↑)**

 - In the DR screen, MENU screen, or Quick Menu window, push to move the value or option selector bar up. (pp. 13, 21, 49)
 - Hold down for 1 second to capture the calling station's call sign. (p. 55)
- 18 VOLUME CONTROL [VOL]**
Rotate to adjust the audio level. (p. 7)
- 19 CONTROL DIAL [DIAL]**

 - Rotate to select an operating frequency. (p. 16)
 - In the Memory mode, rotate to select a Memory channel.
 - Rotate to select a setting item or value.
 - In the Character Entry mode, rotate to enter characters.
- 20 EXTERNAL MICROPHONE • SPEAKER JACK [MIC/SP]**
Connect an optional speaker microphone or headset. (SP: 3.5 mm (1/8 inch), MIC: 2.5 mm)

 - ① Confirm that the transceiver is OFF before connecting or disconnecting optional equipment.
- 21 USB PORT (Type-C) [USB]**
Connects to an external power source, a PC, or other USB device.
- 22 EXTERNAL DC IN JACK [DC IN]**
Connects to an optional battery charger to charge the attached battery pack.

1 PANEL DESCRIPTION

■ Function display

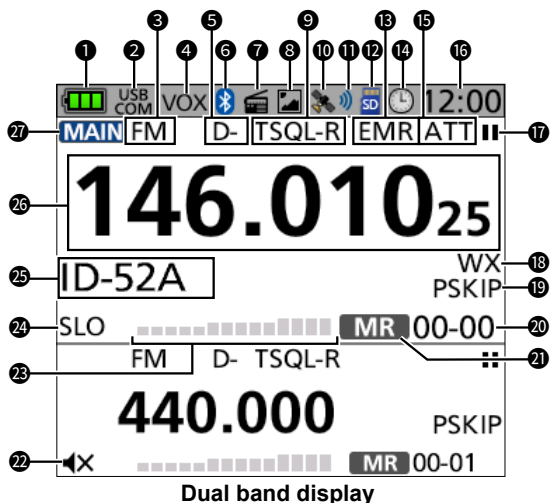

Dual band display

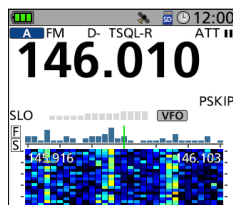

Single band display

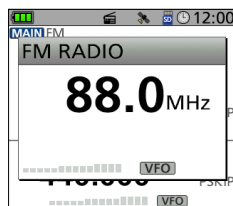

FM RADIO window
(Tuning mode)

1 BATTERY ICON

Displays the current capacity of the attached battery pack. (p. 6)

- ① " " is displayed when the optional battery case is attached.

2 USB CONNECTION INDICATOR

Displayed when a USB device is connected through a USB cable, and "USB Connect" is set to "Serialport." ([MENU] > SET > Function > **USB Connect**)

3 OPERATING MODE ICONS

Displays the selected operating mode. (p. 15)

4 VOX ICON

Displayed when the VOX function is ON.

5 DUPLEX ICONS

- D+: Displayed during plus duplex operation.
- D-: Displayed during minus duplex operation.

6 Bluetooth® ICON

Displayed when a Bluetooth device is connected. (p. 32)

7 FM RADIO ICON

Displayed when the FM radio is ON. (p. 20)

8 PICTURE SHARE ICON

Displayed when the Share Pictures function is ON.

9 TONE ICONS

Displayed when the tone or digital squelch function is ON.

10 GPS ICON

Displays the status of the GPS receiver. (p. 10)

11 GPS ALARM ICON

Displayed when the GPS Alarm function is ON.

12 microSD ICON (p. 8)

- Displayed when a microSD card is inserted.
- Blinks while accessing the microSD card.

13 EMR/BK/PACKET LOSS/AUTO REPLAY ICONS

- **EMR:** Displayed when the Enhanced Monitor Request (EMR) function is ON.
- **BK:** Displayed when the Break-in (BK) function is ON.
- **L:** Displayed when packet loss has occurred.
- **AW :** Displayed when the Auto Reply function is ON.

14 AUTO POWER OFF ICON



Displayed when the Auto Power OFF function is ON.

15 ATTENUATOR ICON

Displayed when the attenuator is ON. (p. 16)

16 CLOCK DISPLAY

17 RECORD ICONS (p. 27)

-  : Displayed while the transceiver is recording.
-  : Displayed while the recording is paused.

18 WEATHER ALERT ICON

Displayed when the Weather Alert function is ON. (Only the ID-52A PLUS)

19 SKIP ICONS

- **SKIP:** Displayed when Memory Skip is selected.
- **PSKIP:** Displayed when Program Skip is selected.

20 MEMORY CHANNEL NUMBER

- In the Memory mode, displays the selected Memory group and Memory channel number.
- In the Call Channel mode, displays "144" or "430" and "C0" or "C1."

21 FREQUENCY SELECTING MODE ICONS

- **VFO :** Displayed while in the VFO mode.
- **MR :** Displayed while in the Memory mode.
- **CALL :** Displayed while in the Call Channel mode.
- **WX :** Displayed while in the Weather Channel mode.
- **DR :** Displayed while the DR function is ON.

22 MUTE ICON

- Displayed when "Sub Band Mute" is set to "Mute" or "Mute & Beep." ([MENU] > SET > Sounds > **Sub Band Mute**)
- Displayed when you select a memory channel that is out of the selectable frequency range on the B band. (p. 11)

23 S/R/F METER

- Displays the relative signal strength of the received signal.
- Displays the output power level of the transmit signal.

24 POWER ICONS

Displays the output power level of the transmit signal in 5 levels (SLO/LO1/LO2/MID/no icon).

- ① When you select HIGH power, the power icon disappears.

25 MEMORY NAME DISPLAY

- ① You can change the display type in the Quick Menu window.

26 FREQUENCY READOUT

Displays an operating frequency.

27 MAIN BAND ICON

- When the Dualwatch function is ON, indicates that the selected band (A or B) is the MAIN band.
- When the Dualwatch function is OFF, indicates the selected band (A or B).
- "AP" is displayed while in the Access Point mode.

TIP: See "About the DV Gateway function" that can be downloaded from the Icom website.

Before starting using the transceiver, follow these steps for the initial setup.

STEP 1 Attaching the battery pack and charging the battery. (pp. 5, 6)

STEP 2 Inserting a microSD card. (p. 7)

STEP 3 Turning ON the transceiver. (p. 7)

STEP 4 Adjusting the audio level. (p. 7)

STEP 5 Saving your initial setting onto a microSD card. (p. 8)

STEP 6 Confirming the GPS signal receiving. (p. 10)

STEP 7 * Entering your Call sign (MY) into the transceiver. (p. 45)

STEP 8 * Registering your call sign at a Gateway repeater. (p. 47)

► **You have completed the steps!!**

* You can skip the steps if you do not plan to operate D-STAR right now.

■ Attaching the Battery pack

Attach or detach the battery pack or battery case, as illustrated below.

① When attaching, slide the battery pack and hold it down until the both latches are locked.

To attach

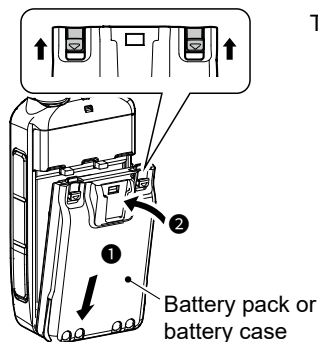

To detach

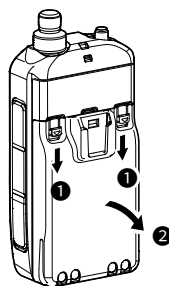





① Illustrations are when using the battery pack.

NOTE:

- Even when the transceiver is OFF, a slight current still flows in the circuits. Remove the battery pack or case from the transceiver when not using it for a long time. Otherwise, the attached battery pack or case will become exhausted, and will need to be recharged or replaced.
- When the temperature is around 0°C (32°F) or below, the Battery Protection function automatically sets the transceiver power to Low1 power (0.5 W), and disables power selections High, Mid, and Low2.

■ Charging the battery pack

◇ Capacity of the battery pack

| ICON | BATTERY STATUS |
|--|--|
|  | The battery has sufficient capacity. |
|  | The battery is exhausted a little. |
|  (green) | The battery is nearing exhaustion. |
|  (red) | The battery is almost fully exhausted. ① Immediately charge the battery pack. Otherwise, the icon will soon start blinking, "LOW BATTERY" will be displayed, and the transceiver will automatically turn OFF. |

To display the correct battery status

Select the attached battery pack in the following item. (Default: BP-271/BP-272)
([MENU] > SET > Function > **Battery Pack Select**)

To display the Battery Pack Select dialog every time you attach the battery pack, set the following item to "ON."

([MENU] > SET > Function > **Battery Pack Confirmation**)

NOTE:

- Before using the transceiver for the first time, the battery pack must be fully charged for optimum life and operation.
- **BE SURE** to turn OFF the transceiver while charging. Otherwise, the attached battery pack cannot be charged.
- While charging, the charging icon  and "Charging...." are displayed.
- The icon and "Charging...." disappear when the battery pack is fully charged.
- You may not be able to charge:
 - Depending on your USB cable or power adapter.
 - When using a USB hub or connecting to a low output USB port.
- Charging time may differ, depending on the USB port.
- To use a mobile device or a PC as an external power source, set the following item to "ON" (default). ([MENU] > SET > Function > **USB Power Input (Phone, Tablet, PC)**)

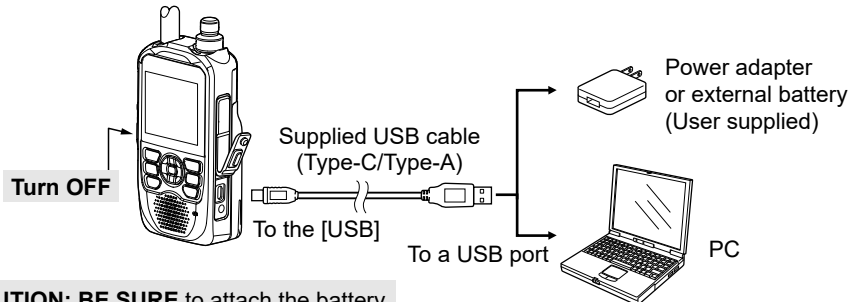

CAUTION: BE SURE to attach the battery pack before connecting the USB cable.

① See the Advanced manual about the optional battery packs and chargers.

2 INITIAL SETUP

■ Inserting a microSD card

See page 25 for the usable microSD card.

1. Turn OFF the transceiver.
2. Pull down the [microSD] slot cover on the side panel.
3. With the terminals facing the front, insert the card into the slot until it locks in place and makes a 'click' sound.
④ When removing, push in the microSD card until a 'click' sounds. The card is unlocked, and you can pull it out.

NOTE:

- **DO NOT** touch the terminals.
- **DO NOT** remove the card from the transceiver while the card is being accessed. Otherwise, the card data may be corrupted or deleted.

4. Completely close the [microSD] slot cover.

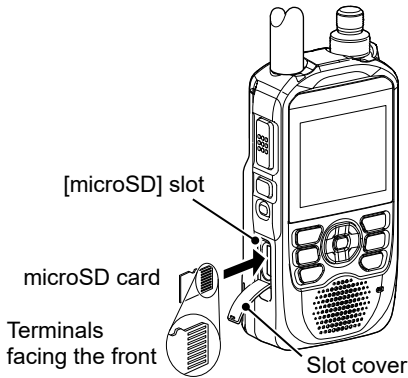

CAUTION: DO NOT forcibly or inversely insert the card. It will damage the card or the slot.

■ Turning ON the transceiver

- Hold down [POWER] for 1 second to turn ON the transceiver.
 - A beep sounds.
 - After the opening message and remaining battery capacity are displayed, the operating frequency or repeater name is displayed.
- Hold down [POWER] for 1 second again to turn OFF the transceiver.

■ Adjusting the audio level

- Rotate [VOL] to adjust the audio level.
④ The display shows the audio level while adjusting.

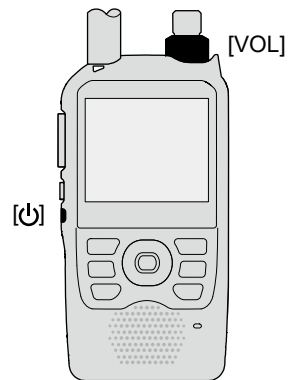

■ Saving the setting data onto a microSD card

You can save the Memory channels, MENU screen item settings, repeater lists, and so on, onto a microSD card.

Saving settings onto a card enables you to easily restore the transceiver to its previous settings, even if you perform an All Reset.

◇ Formatting a microSD card

IMPORTANT! Before using a microSD card for the first time, format it in the transceiver. Formatting a card erases all its data. Before formatting any used card, back up its data onto another device.

[MENU] > SET > SD Card > **Format**

- Turn ON the transceiver.
 - If a microSD card is inserted, the microSD icon  is displayed.
 - While accessing, the icon blinks.
 - Push [MENU].
 - Select "SD Card" in the "SET" menu.
 - Select "Format."
 - The confirmation dialog is displayed. - Select "Yes."
 - The formatting starts, and the display shows the formatting progress.
 - After the formatting ends, returns to the SD CARD screen.
- ① If "The GPS Logger function is activated." and/or "The QSO Log function is activated." are displayed, turn OFF the functions or ignore the messages and select "YES."
- ① To exit the MENU screen, push [MENU].

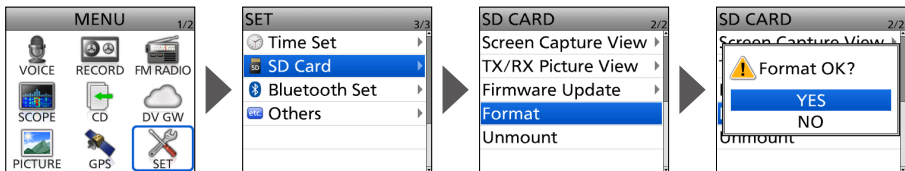

2 INITIAL SETUP

■ Saving the setting data onto a microSD card

◇ Saving the setting data

[MENU] > SET > SD Card > **Save Setting**

1. Push [MENU].
2. Select "SD Card" in the "SET" menu.
3. Select "Save Setting."
4. Select "<<New File>>".
 - The FILE NAME screen is displayed.
 - ① The file name is automatically set in the following format:
SetYYYYMMDD_xx (YYYY: Year, MM: month, DD: day, xx: serial number).
5. Push [ENT] to save the file with the displayed name.
 - The confirmation dialog is displayed.
6. Select "YES."
 - Saves the setting data.
 - While saving, a progress bar is displayed, then returns to the SD CARD screen after the saving is completed.
 - ① To exit the MENU screen, push [MENU].

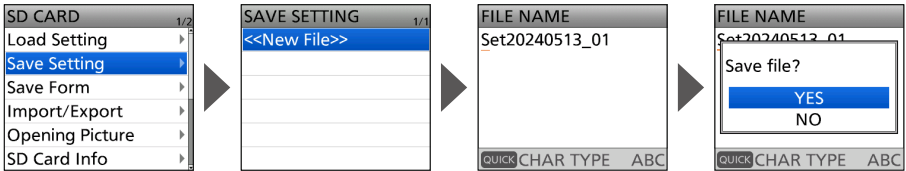

TIP: You can edit the saved settings on your PC using the optional CS-52PLUS PROGRAMMING SOFTWARE.

■ Confirming the GPS is receiving signals

The transceiver has a built-in GPS receiver. You can check your current location, and transmit GPS data in the DV mode. See the Advanced manual for details.

Confirm the GPS receiver is receiving satellite data.

The GPS icon blinks when searching for satellites.

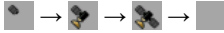

The GPS icon stops blinking when the minimum needed number of satellites are found.



- ① It may take only a few seconds to receive, or it may take a few minutes, depending on your operating environment. If you have difficulties receiving, we recommend that you try a different location.
- ① When "GPS Select" is set to "Manual," the icon is not displayed.
([MENU] > GPS > GPS Set > **GPS Select**)

NOTE: If you cannot receive GPS data, manually set the date and time.
([MENU] > SET > Time Set > **Date/Time**)

TIP: To prolong the battery life in the GPS mode

Manually update your location with the received GPS data.

1. Confirm the GPS receiver is receiving your location data. (See above).
2. Display the MANUAL POSITION screen.
([MENU] > GPS > GPS Set > **Manual Position**)
3. Push [QUICK].
 - The Quick Menu window is displayed.
4. Select "Capture From GPS."
5. Set "GPS Select" to "Manual."
([MENU] > GPS > GPS Set > **GPS Select**)

TIP: The GPS log data is saved onto the microSD card. (p. 30)

■ Receiving

The following are basic settings for receiving.

- Setting the Dualwatch function. (p. 11)
- Selecting the Frequency Selecting mode. (p. 14)
- Selecting the operating band. (p. 15)
- Selecting the operating mode. (p. 15)
- Setting a frequency. (p. 16)
- Setting a squelch level. (p. 12)

■ Dualwatch operation

The Dualwatch function simultaneously monitors 2 frequencies. The ID-52A PLUS/ID-52E PLUS has 2 independent receiver circuits, A band and B band. You can set different frequencies or operating modes in each band.

- ① Selectable frequency differs, depending on the transceiver version and the A/B bands. See the specifications for details. (p. 34)
- ① When the Dualwatch function is ON, the audio output may be interrupted when the frequency is switched while scanning, or by other factors.

◇ Turning Dualwatch ON or OFF

- Hold down [DUAL] for 1 second to turn the Dualwatch function ON or OFF.
 - When the Dualwatch function is ON, the display shows the A band in the upper half and the B band in the lower half of the display.
 - ① "MAIN" is displayed on the MAIN band, where you can change the settings.
 - ① The SUB band can be automatically muted. ([MENU] > SET > Sounds > **Sub Band Mute**)
 - When the Dualwatch function is OFF, the display shows only the MAIN band. Push [MAIN] to select the A or B band.
 - ① On the B band, if you select a memory channel that is out of the selectable frequency range, "X" is displayed, and the signal cannot be received.

◇ MAIN band selection

- Push [MAIN] to alternately set the A band or B band as the MAIN band.
 - "MAIN" is displayed on the MAIN band, where you can change the settings.
 - ① Band selection, receive frequency setting, receive mode selection, Memory channel selection, the Memory Write operation, the Band Scope operation can be made only on the MAIN band.

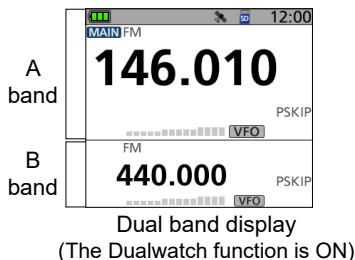

■ Monitor function

The Monitor function is used to listen to weak signals without changing the squelch setting.

- While holding down [SQL], you can hear weak signals on the frequency.

TIP: You can set the Monitor Hold function on the MENU screen. The transceiver opens or closes the squelch each time you push [SQL].
 ([MENU] > SET > Function > **Monitor**)



The first segment blinks.

■ Setting a squelch level

Noise squelch enables the audio to be heard only while receiving a signal that is stronger than the set level. A higher level blocks weak signals, which enables you to receive only stronger signals. A lower level enables you to hear weak signals.

① Throughout this document, “Noise squelch” is simply called “Squelch.”

- While holding down [SQL], rotate [DIAL] to select the squelch level.

① Information

- Options: “OPEN,” “AUTO” (default), and “LEVEL 1” ~ “LEVEL 9”
- “LEVEL 1” is loose squelch (for weak signals) and “LEVEL 9” is tight squelch (for strong signals).
- “AUTO” is an automatic level adjustment using a noise pulse counting system.
- “OPEN” is the continuously open setting.
- In the DV mode, you cannot set the squelch to “OPEN.”



Automatic squelch



Maximum squelch level

3 BASIC OPERATION

■ Quick Menu window

You can open the Quick Menu window by pushing [QUICK]. In the window, the selectable items may differ, depending on the operating mode or function. The items listed below are examples.

| VFO mode | Memory mode | Call CH mode | Weather CH mode*5 | DR function |
|---------------------|----------------------|---------------------|---------------------|---------------------------------|
| Band Select | Group Select | DUP | GPS Information | <<Select from All Repeaters>>*6 |
| DUP | Channel Select Group | TONE*1 | GPS Position | Group Select |
| TONE*1 | DUP | D.SQL *2 | Weather Alert | Repeater Detail |
| D.SQL *2 | TONE*1 | TS | Voltage | ATT*4 |
| TS | D.SQL *2 | ATT*4 | <<REC Start>> | DTMF TX |
| ATT*4 | TS | DTMF TX*3 | <<FM Radio ON>> | Voice TX |
| DTMF TX*3 | ATT*4 | Voice TX*3 | <<FM Radio Mode>> | GPS Information |
| Voice TX*3 | SKIP | GPS Information | <<GPS Logger Only>> | GPS Position |
| GPS Information | DTMF TX*3 | GPS Position | | Weather Alert*5 |
| GPS Position | Voice TX*3 | Weather Alert*5 | FM Radio | Display Type |
| Weather Alert*5 | GPS Information | Display Type | <<FM Radio OFF>> | D.SQL |
| Home CH Set | GPS Position | Voltage | MR | SKIP |
| Voltage | Weather Alert*5 | Band Scope | ATT | Home CH Set |
| Band Scope | Home CH Set | <<REC Start>> | <<FM Radio Mode>> | Voltage |
| <<REC Start>> | Display Type | <<FM Radio ON>> | | Memory Scope |
| <<FM Radio ON>> | Voltage | <<FM Radio Mode>> | | <<REC Start>> |
| <<FM Radio Mode>> | Memory Scope | <<GPS Logger Only>> | | <<FM Radio ON>> |
| <<GPS Logger Only>> | <<REC Start>> | | | <<FM Radio Mode>> |
| | <<FM Radio ON>> | | | <<GPS Logger Only>> |
| | <<FM Radio Mode>> | | | |
| | <<GPS Logger Only>> | | | |

*1 For only FM/FM-N. *2 For only DV.

*3 For only FM/FM-N/DV.

*4 For only A band.

*5 For only the ID-52A PLUS.

*6 For selecting the nearest repeater.

◇ Quick Menu window operation

Simplified description—'Select' operation

In this manual, the user's 'Select' operation is simplified, as described below.

Simplified description:

1. Push [QUICK].
2. Select "TS."

Operation:

1. Push [QUICK] to open the Quick Menu window.
2. Push D-pad(↑) to select "TS," and then push [ENT].

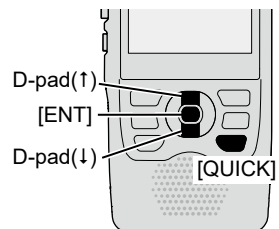

■ Selecting the Frequency Selecting mode

◇ VFO mode

Rotate [DIAL] to set an operating frequency.

① In the VFO mode, **VFO** is displayed.

◇ Memory mode

Select a Memory channel where an operating frequency and other parameters are saved.

① In the Memory mode, **MR** and the Memory Channel number are displayed.

◇ Call Channel mode

Select a Call Channel to recall your most-often used frequencies quickly.

① In the Call Channel mode, **CALL** and the Call Channel number are displayed.

◇ Weather Channel mode (For only the ID-52A PLUS)

Weather Channels are used for monitoring Weather Channels from the National Oceanographic and Atmospheric Administration (NOAA) broadcasts.

① In the Weather Channel mode, **WX** is displayed.

1. Select a mode.

① Information

- Push [VFO/MHz] to select the VFO mode.
- In the VFO mode, push [VFO/MHz] to select the 1 MHz tuning step.
- Push [MR] to select the Memory mode.
- Hold down [CALL] for 1 second to select the Call Channel mode.
- For only the ID-52A PLUS, push [MR] in the Memory mode to select the Weather Channel mode.

2. Rotate [DIAL] to select an operating frequency or a channel.



VFO mode



Memory mode



Call Channel mode



Weather Channel mode

■ DR function operation

Using the D-STAR Repeater (DR) function, you can easily select the entered repeaters and Your call signs by rotating [DIAL]. You can make not only a repeater call but also a simplex call.

- Hold down [DR] for 1 second.
 - Displays the DR screen.
- ① Hold down [DR] again to cancel the DR function.
- ① See D-STAR GUIDE (p. 40) for the DR function details.



3 BASIC OPERATION

■ Selecting the operating band

1. Push [VFO/MHz] to select the VFO mode.
2. Push [QUICK].
3. Select "Band Select."
4. Select the desired frequency band.
 - Sets the operating band, then returns to the standby screen.
 - ① Selectable frequency bands differ, depending on the transceiver version. See the specifications for details. (p. 34)

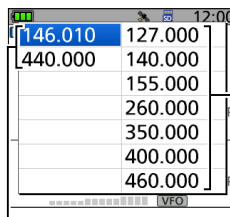
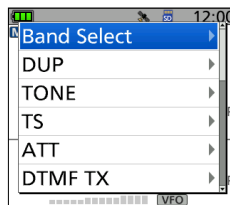

Transmit and receive

Receive only

■ Selecting the operating mode

The transceiver has 5 operating modes, FM, FM-N, AM, AM-N, and DV.

- Push [MODE] to select the operating mode.

① Information

- In the FM-N mode, the TX modulation is automatically set to narrow (approximately ± 2.5 kHz).
- The AM-N mode can be used for only 108.000 MHz ~ 143.995 MHz.
- On 108.000 MHz ~ 136.991 MHz, you can use only AM or AM-N.
- On the Ham band, you can use only FM, FM-N, or DV.
- When the GPS TX mode is selected in the DV mode,  is displayed.
([MENU] > GPS > **GPS TX Mode**)

TIP: You can make a simplex call not only in the FM mode but also in the DV mode.



FM mode

■ Setting a frequency

◇ Selecting a tuning step

When you select the frequency by rotating [DIAL] in the VFO mode, it changes in the selected tuning step.

1. Push [QUICK].
2. Select "TS."
3. Select a tuning step.

Options (kHz):

| | | | | | | |
|------|------|-------|-------|-------|-------|-------|
| 5.0 | 6.25 | 8.33* | 10.0 | 12.5 | 15.0 | 20.0 |
| 25.0 | 30.0 | 50.0 | 100.0 | 125.0 | 200.0 | Auto* |

* For only 108.000 MHz ~ 136.991 MHz

- Sets the tuning step, then returns to the standby screen.

① Information

- You can set the tuning step for both the VFO and Memory mode.
- The VFO mode scan and the Band Scope function also use this step to search for signals.
- On 108.000 MHz ~ 136.991 MHz, you can select only 8.33 kHz, 25.0 kHz, or Auto.

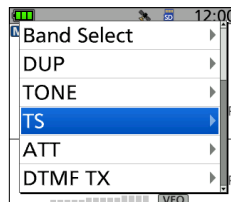

◇ Selecting the 1 MHz tuning

You can change the operating frequency in 1 MHz steps for quick tuning.

1. In the VFO mode, push [VFO/MHz].
 - Enters the 1 MHz Tuning Select mode, and the 1 MHz digit blinks.
 2. Rotate [DIAL].
 - The frequency changes in 1 MHz steps.
 3. Push [VFO/MHz].
 - Exits the 1 MHz Tuning Select mode.
- ① The tuning step setting (above) remains.



The 1 MHz Tuning Select mode

■ Attenuator

The Attenuator prevents a desired signal from becoming distorted when a very strong signal is near the frequency, or when a very strong electric field, such as from a broadcasting station, is near your location.

① You can use the Attenuator only on the A band.

1. Push [QUICK].
2. Select "ATT."
3. Select "ON."
 - "ATT" is displayed.



The Attenuator is ON.

3 BASIC OPERATION

■ Scan operation

Scanning is a versatile function that can automatically search for signals. A scan makes it easier to locate stations to contact or listen to, or to skip unwanted channels or frequencies.

This section describes the basic scan operation. See the Advanced manual for details.

Example: Scanning in the VFO mode

1. Push [VFO/MHz] to enter the VFO mode.
2. Hold down [SCAN] for 1 second.
 - Opens the Scan Type Select window.
3. Select "ALL."
 - The scan starts.
 - The decimal point and the selected scan type icon blink.
 - ④ When receiving a signal, the S-meter displays the received signal strength.
4. Push [CLR].
 - Cancels the scan.

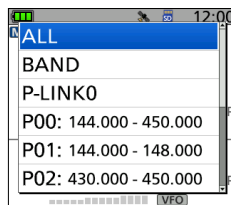

■ Speech function

The Speech function audibly announces the displayed frequency and mode by holding down [SPCH] for 1 second.

Also, you can set various Speech functions, such as the DIAL Speech function or Mode Speech function in the MENU screen.

([MENU] > SET > SPEECH > **DIAL SPEECH**)

([MENU] > SET > SPEECH > **MODE SPEECH**)

④ Information

- In the VFO, Memory, or Call Channel mode, the Speech function announces the current frequency and operating mode.
- When using the DR function, the Speech function announces the displayed call sign.



■ Home Channel function

You can set an often-used frequency, Memory channel, or repeater as a Home Channel in VFO mode, Memory mode, and DR screen. When a Home CH is selected by rotating [DIAL], a beep sounds. You will know the Home CH selection without looking at the display.

◇ Setting a Home Channel

1. Select the VFO or Memory mode, or the DR screen to set a Home Channel. (p. 14)
2. Select a frequency, Memory channel, or an access repeater to be set as a Home Channel. (p. 16)
3. Push [QUICK].
4. Select "Home CH Set."
5. Select "Set Frequency" (VFO mode), "Set Channel" (Memory mode), or "Set Repeater" (DR screen).
 - Sets a Home Channel, then returns to the standby screen.

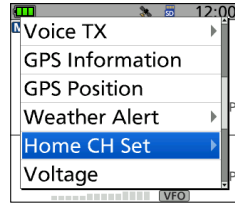

■ Transmitting

◇ Making a simplex call

⚠ WARNING! NEVER transmit for long periods of time. During prolonged transmissions at high power or mid-power, the transceiver radiates heat to protect itself from overheating. The transceiver's chassis will become hot and may cause a burn. To prevent the transceiver's overheating, the default setting of the time-out timer function is set to 5 minutes. Be careful when the time-out timer function is turned OFF or set to a long time period, and you transmit for long periods.

CAUTION: DO NOT operate the transceiver where heat dissipation will be obstructed if the transceiver is also being charged with an external power supply. Poor heat dissipation may cause a burn, warp the casing, or damage the transceiver.

CAUTION: DO NOT transmit without an antenna.

NOTE: When the transceiver becomes hot, the transceiver's heat protection function gradually reduces the output power to approximately 2.5 watts, then it stops transmission after that. This is done to protect the transceiver itself until it can cool down.

NOTE: You can transmit on only the amateur frequency bands.

IMPORTANT: Before transmitting, monitor the operating frequency to make sure transmitting won't cause interference to other stations on the same frequency.

3 BASIC OPERATION

■ Transmitting

◇ Making a simplex call

1. Select the operating mode. (p. 15)
2. Rotate [DIAL] to set the operating frequency. (p. 16)
3. Hold down [LO] for 1 second to select an output power.
 - The Select Output Power window is displayed.

① Information

- You can select S-Low, Low1, Low2, Mid, or High.
 - You can also select an output power by rotating [DIAL] while holding down [LO].
 - When you select a high power, the power icon disappears.
 - Select a level to suit your operating requirements.
4. Hold down [PTT] to transmit, and speak into the microphone at your normal voice level.
 - The TX/RX indicator lights red.
 - The S/R/F meter displays the output power level.
 5. Release [PTT] to receive.

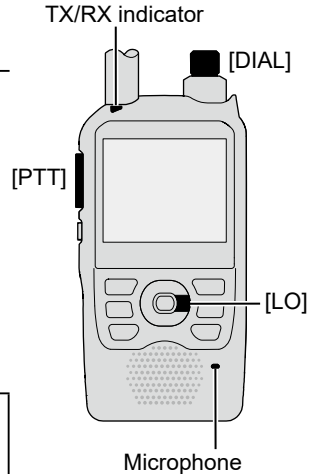

TIP: To maximize the readability of your signal

1. After pushing [PTT], pause briefly before you start speaking.
2. Hold the microphone 5 to 10 cm (2 to 4 inches) from your mouth, then speak at your normal voice level.

◇ About the transmit power levels

- When an external DC power cable (13.5 V DC) is connected, or a BP-271/BP-272/BP-307 is used:
Approximately 5 W (High)/2.5 W (Mid)/
1.0 W (Low2)/0.5 W (Low1)/0.1 W (S-Low)
- When the BP-273 is used:
Approximately 0.1 W (S-Low) (fixed)

NOTE: When using the BP-273, you can select "S-Low," "Low1," "Low2," "Mid," or "High." However, "SLO" is displayed while transmitting, and the output power is limited to approximately 0.1 watts.

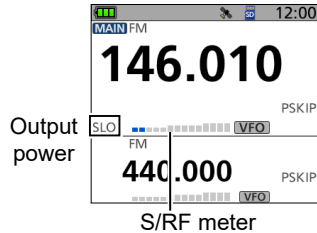

■ FM Radio operation

◇ Turning ON the FM Radio

1. Push [QUICK].
2. Select “<<FM Radio ON>>.”
 - Returns to the standby screen, and the FM RADIO window is displayed.
 -  is displayed.

TIP: To turn OFF the FM Radio, push [QUICK], and then select “<<FM Radio OFF>>.”

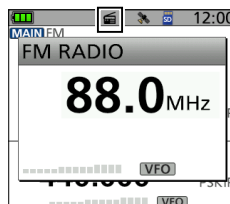

■ Lock function

Activate to prevent accidental frequency changes and unnecessary function access.

- Hold down [P-O] for 1 second to turn ON the Key Lock function.
 - When the Key Lock function is ON, and the locked key or [DIAL] is pushed or rotated, “LOCK ON” is displayed.

① Information

- To turn OFF the function, hold down [LOCK] for 1 second again (Until “LOCK OFF” is displayed).
- [D], [PTT], [SQL], and [VOL] can be used even if the Key Lock function is ON.
- You can change the keys to be locked on the MENU screen.
([MENU] > SET > Function > **Key Lock**)

■ Band Scope/Memory Scope function

Use the Scope function to visually search a specified range around the displayed frequency or channels. You can use this function to search for a signal, and see the relative received signal strength level.

On the single band display, you can confirm the signal strengths over time by the waterfall function. See the Advanced manual for details.

Waterfall zone

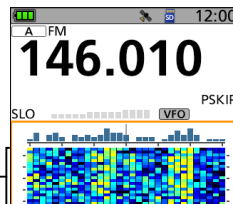

Band Scope zone
(with a line in orange)

1. Push [MENU].
2. Select “SCOPE.”
 - Returns to the standby screen, and starts the continuous sweep.
3. Push [CLR] twice to turn OFF the Scope function.

You can open the MENU screen by pushing [MENU].

You can use the MENU screen to set infrequently changed values or function settings.

See the appendix for the MENU item list. (p. 71)

For details of each item, see the Advanced manual.

The MENU screen

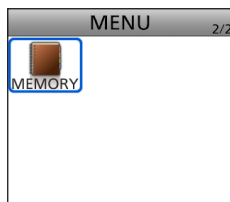

TIP: The MENU screen is constructed in a tree structure. You may go to the next tree level, or go back a level, depending on the selected item.

■ Selecting a Menu item

◇ MENU screen operation

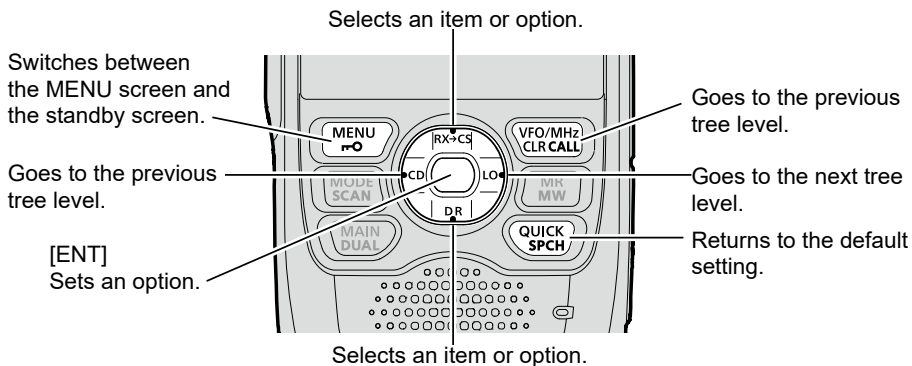

Simplified description—'Select' operation

In this manual, the user's 'Select' operation is simplified, as described below.

Simplified description:

1. Push [MENU].
2. Select "30min."

Operation:

1. Push [MENU] to open the MENU screen.
2. Push D-pad(↑) to select "30min," and then push [ENT].

◇ Selecting a Menu item

Example: Set “Auto Power OFF” to “30 min.”

[MENU] > SET > Time Set > **Auto Power OFF**

1. Push [MENU].
2. Select “SET.”
3. Select “Time Set.”
4. Select “Auto Power OFF.”
5. Select “30min.”
 - Sets the option, then goes back to a tree level. (The TIME SET screen is displayed.)
 - ① To exit the MENU screen, push [MENU].

The Auto Power OFF icon is displayed.

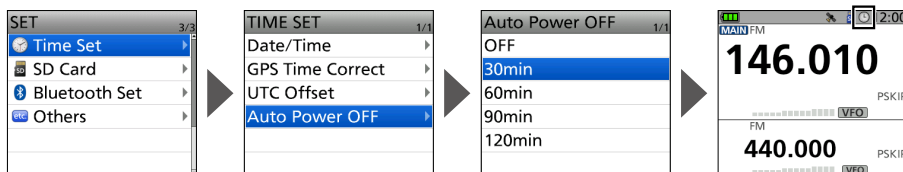

TIP: To return to the default setting

1. Push [QUICK] in step 5.
2. Select “Default.”
 - The setting returns to the default.

① The default settings of each item are described in the Advanced manual.

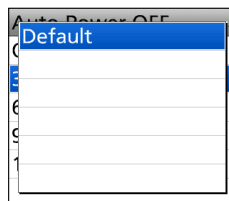

■ Entering Memory channels

The transceiver has a total of 1000 Memory channels to save often-used frequencies. In the Memory mode, you can quickly select the saved memories. This section describes the basic channel content entry.

Example: Entering 146.030 MHz/FM mode into Channel 11 in Group 01.

1. Push [VFO/MHz] to enter the VFO mode.
2. Push [MODE] to enter the FM mode.
3. Rotate [DIAL] to set a frequency to 146.030 MHz.
4. Hold down [MW] for 1 second.
 - A short and a long beep sound.
5. Select "Write to New CH."
6. Push [QUICK].
7. Select "Group Select."
8. Select Group "01."
9. Rotate [DIAL] to select Channel "11."
10. Push [ENT].
 - The confirmation dialog is displayed.
11. Select "YES."
 - Beeps sound and the Memory contents are briefly displayed, then returns to the VFO mode.

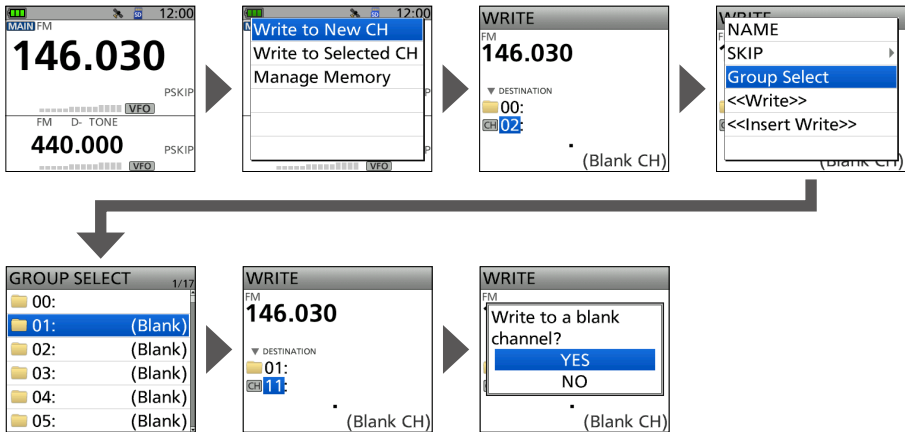

TIP: Holding down [MW] for 3 second in step 4 enters the contents into a blank channel.

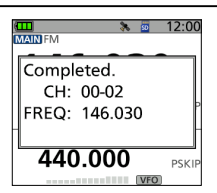

■ Selecting a Memory channel

In the Memory mode, you can select the Memory channels by rotating [DIAL].

1. Push [MR] to enter the Memory mode.
 - ① For only the ID-52A PLUS, pushing [MR] alternately selects the Memory and Weather Channel modes.
2. Rotate [DIAL].
 - Selects a Memory channel.
 - ① To select the Memory group, push [QUICK], and then select “Group Select.”
 - ① Blank channels are not selected.

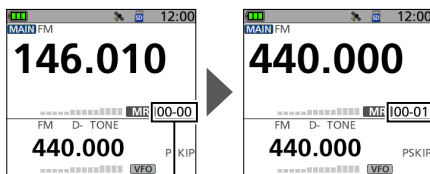

Memory group number and channel number

TIP: To sequentially select a channel in a different group
Set “Channel Select Group Range” to “All Groups” in the Quick Menu window.

■ Viewing the Memory channel contents

You can view the Memory channel contents on the MEMORY screen.

Example: Viewing the contents of Channel 01 in Group 00.

[MENU] > MEMORY > **Memory CH**

1. Push [MENU].
2. Select “MEMORY” on page 2 of the MENU screen.
3. Select “Memory CH.”
4. Select Group “00.”
5. Select Channel “01.”
 - Channel contents are displayed.
 - ① Rotate [DIAL] to scroll the screen.
 - ① To exit the MENU screen, push [MENU].

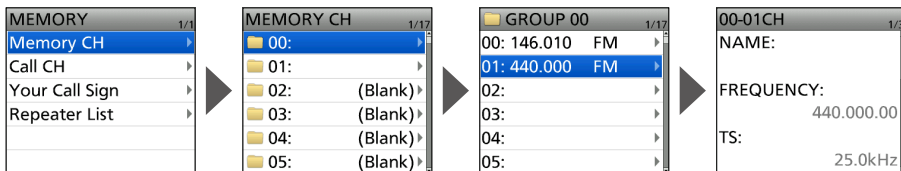

■ About the microSD card

NOTE: The microSD, microSDHC, and microSDXC cards are not available from Icom (User supplied).

A microSD card of up to 2 GB, a microSDHC of up to 32 GB, or a microSDXC of up to 256 GB can be used in this transceiver. Icom has checked the compatibility with the following cards. (As of December 2024)

| Brand | Type | Capacity |
|----------|-----------|----------|
| SanDisk® | microSD | 2 GB |
| | microSDHC | 4 GB |
| | | 8 GB |
| | | 16 GB |
| | | 32 GB |
| | | 64 GB |
| | microSDXC | 128 GB |
| | | 256 GB |

- ① The performance of the cards listed to the left is not guaranteed.
- ① Throughout this document, the microSD card, microSDHC, and microSDXC card are simply called the microSD card or the card.
- ① Before using the microSD card, format it using the transceiver, even a preformatted card for PCs or other uses. (p. 8)

TIP: Saving the factory default data is recommended. (p. 9)
 ([MENU] > SET > SD Card > **Save Setting**)

NOTE:

- Before using the microSD card, thoroughly read the instructions of the card.
- If you do any of the following, the card data may be corrupted or deleted.
 - You remove the card from the transceiver while accessing the card.
 - You change the external power supply's voltage while accessing the card.
 - You drop, impact, or vibrate the card.
- **DO NOT** touch the contacts of the card.
- The transceiver takes a longer time to recognize a high capacity card.
- The card will get warm if used continuously for a long period of time.
- The card has a certain lifetime, so data reading or writing may not be possible after using it for a long period of time.
- When reading or writing data is impossible, the card's lifetime has ended. In this case, purchase a new one. We recommend you make a backup file of the important data onto your PC.
- Icom will not be responsible for any damage caused by data corruption of a card.

■ Setting the Record operation

You can select whether or not to start or stop an audio recording only on the MAIN band.

[MENU] > RECORD > QSO Recorder > Recorder Set > **REC Operation**

1. Push [MENU].
 2. Select “QSO Recorder” in the “RECORD” menu.
 3. Select “Recorder Set.”
 4. Select “REC Operation.”
 5. Select “A/B Separate” or “A/B Link.”
 - A/B Separate: The recording function is separately active/inactive on the selected band (MAIN band) when the function is started or stopped.
 - A/B Link: The recording function is simultaneously active/inactive on both MAIN and SUB bands when the function is started or stopped.
 - ① On the single band display, only displayed band (A or B) is recorded.
- ① To exit the MENU screen, push [MENU].

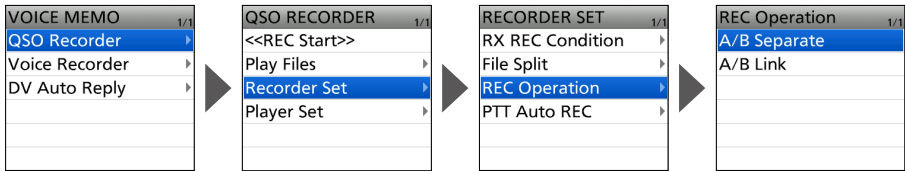

6 RECORDING A QSO ONTO A microSD CARD



■ Recording a QSO audio

NOTE:

- Once a voice recording starts, the Recording function will be continuously turned ON until you stop recording, even if you turn OFF the transceiver.
- FM Radio audio cannot be recorded.

1. Push [QUICK].
2. Select “<<REC Start>>.”
 - “Recording started” is displayed.

① Information

-  is displayed while recording.
-  is displayed while the recording is paused.
- Recording continues until you stop recording, or the card becomes full.

3. Push [QUICK].
4. Select “<<REC Stop>>.”
 - “Recording stopped” is briefly displayed, and voice recording stops.

TIP: As the default setting

- The recording is paused while the squelch is closed, and resumes when a signal is received. ([MENU] > RECORD > QSO Recorder > Recorder Set > **RX REC Condition**)
- The recording automatically starts when you start to transmit, even if the Recording function is turned OFF. ([MENU] > RECORD > QSO Recorder > Recorder Set > **PTT Auto REC**)

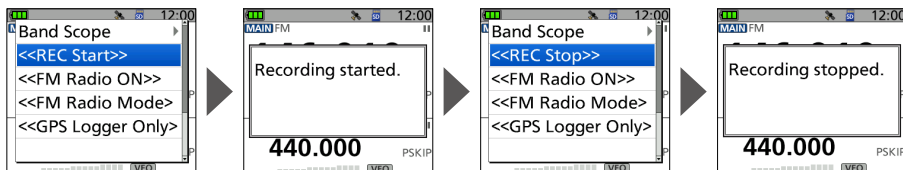

■ Playing a recorded audio

[MENU] > RECORD > QSO Recorder > **Play Files**

1. Push [MENU].
2. Select “QSO Recorder” in the “RECORD” menu.
3. Select “Play Files.”
4. Select the folder that contains the file you want to play.
 - ① The folder is named YYYYMMDD (Y: year, M: month, D: day).
5. Select the file that you want to play.
 - The VOICE PLAYER screen is displayed and starts playing.
 - ① To pause, push [ENT]. To restart, push [ENT] again.
 - ① To exit the MENU screen, push [MENU].

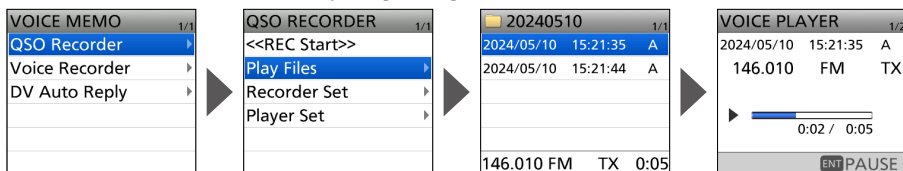

■ Removing the microSD card

◇ Removing while the transceiver is OFF

1. Turn OFF the transceiver.
2. Open the [microSD] slot cover.
3. Push in the microSD card until a 'click' sounds, and then carefully pull it out.
 - ① **DO NOT** touch the terminals.
4. Completely close the [microSD] slot cover.

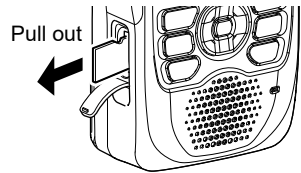
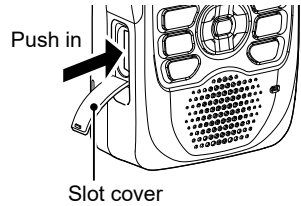

◇ Removing while the transceiver is ON

[MENU] > SET > SD Card > **Unmount**

1. Push [MENU].
2. Select "SD Card" in the "SET" menu.
3. Select "Unmount."

 - The confirmation dialog is displayed.

4. Select "YES."

 - When the unmounting is completed, "Unmount is completed." is briefly displayed, then the display automatically returns to the SD CARD screen.

5. Push in the microSD card until a 'click' sounds, and then carefully pull it out.
 - ① See "Removing while the transceiver is OFF" for details.
6. Completely close the [microSD] slot cover.

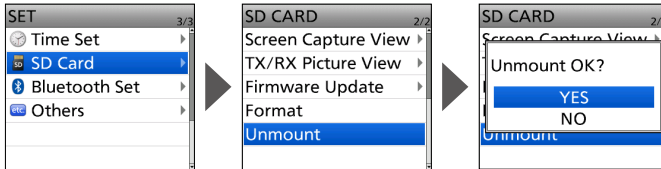

NOTE: After removing the microSD card, completely close the [microSD] slot cover as shown to the right.

Close the slot cover firmly

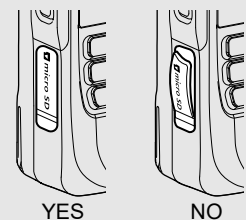

NOTE: The built-in GPS receiver cannot calculate its location if it cannot receive signals from the GPS satellites. Refer to page iv for details.

■ Checking your location

You can check your current location.

If you transmit while displaying the GPS POSITION screen, the screen closes.

To check your current location or caller's location while transmitting, push [QUICK], then select "GPS Position."

◇ Displaying Location Data

1. Confirm the GPS icon is displayed.
2. Push [QUICK].
3. Select "GPS Position."
 - The GPS POSITION screen is displayed.
4. Push D-pad (↑).
 - Changes between the MY (My position), RX (Received position), MEM (GPS Memory position), and ALM (GPS Alarm position) screen.
5. Push [CLR].
 - Returns to the standby screen.

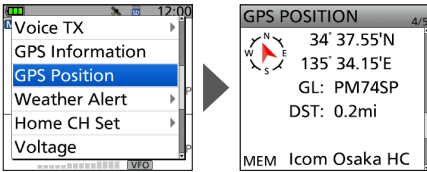

(Example: Displays GPS Memory position.)

About the GPS POSITION screen

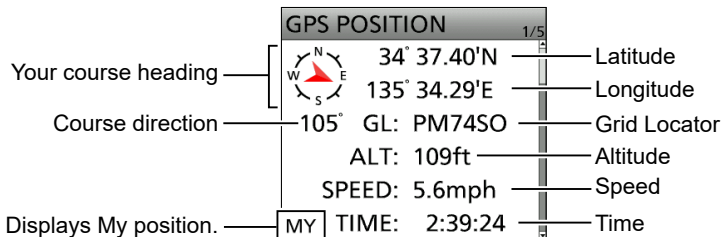

■ GPS Logger function

The GPS Logger function enables you to save the location data from a GPS receiver onto a microSD card as a log. The GPS Logger saves Latitude, Longitude, Altitude, Positioning state, Course, Speed, Date, and Time.

If you use this GPS Logger while traveling, you can check your trip history on mapping software.

About the log file

If you have the log file imported to mapping software, you can display your route as you move on to the software map.

- ① The log files may not be compatible with all mapping software.
- ① See "Using the GPS Logger function" that can be downloaded from the Icom website for details on copying the log files onto your PC.

NOTE:

- The GPS Logger function requires a microSD card (User supplied). See page 7 for details.
- This function is turned ON as the default setting. Therefore when you insert a microSD card, this function continuously saves the location data from the GPS receiver, even if you turn OFF the transceiver, then ON again.
To turn OFF the function, do the steps below.
- When the microSD card is full, this function will automatically be paused.

◇ Turning OFF the GPS Logger function

You can turn OFF the GPS Logger function by following the steps below.

[MENU] > GPS > GPS Logger > **GPS Logger**

1. Push [MENU].
 2. Select "GPS Logger" in the "GPS" menu.
 3. Select "GPS Logger."
 4. Select "OFF."
- ① To exit the MENU screen, push [MENU].

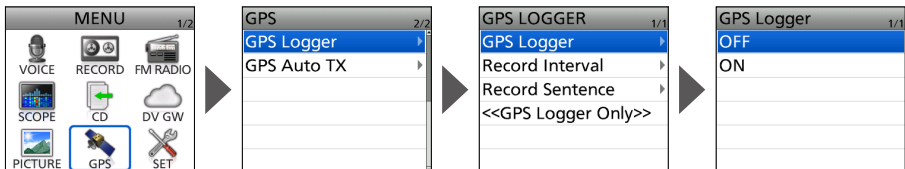

The transceiver has a built-in Bluetooth unit. You can connect Bluetooth headsets or other Bluetooth devices. When you connect a Bluetooth headset to the transceiver, you can wirelessly transmit and receive it. Refer to the Advanced manual for more details on the Bluetooth function or VS-3 operation.

① The communication range of Bluetooth is approximately 10 meters (33 feet).

IMPORTANT: The Bluetooth communication range may vary, depending on the environment in which the device operates. Microwave ovens or Wireless LAN may cause interference. In that case, stop using those devices or increase the space between the Bluetooth device and the other devices. All Bluetooth devices have a range of use. If the communication is unstable, use the device within the range.

NOTE: Connect with a device that complies with the standards set by Bluetooth SIG and has been certified.

Even if the device complies with the Bluetooth standard, it may not be able to connect to the receiver, depending on the specifications and settings of the device, and not all operations are guaranteed.

■ Turning ON the Bluetooth® function

[MENU] > SET > Bluetooth Set > Bluetooth

1. Push [MENU].
 2. Select "Bluetooth Set" in the "SET" menu.
 3. Select "Bluetooth."
 4. Select "ON."
- ① To exit the MENU screen, push [MENU].

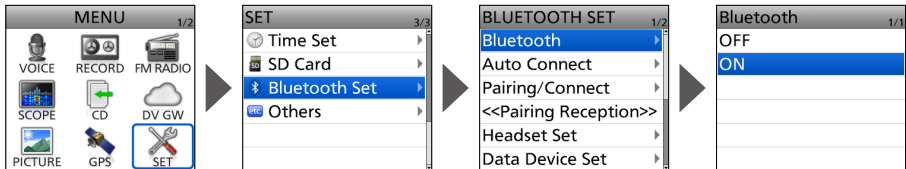

■ Connecting to a Bluetooth® headset

You can connect an optional Bluetooth headset to the transceiver.

Step 1. Selecting the pairing mode of the headset.

See the instruction manual of the headset to select the pairing mode.

Step 2. Searching for the headset (Transceiver)

[MENU] > SET > Bluetooth Set > **Pairing/Connect**

1. Push [MENU].
2. Select "Bluetooth Set" in the "SET" menu.
3. Select "Pairing/Connect."
4. Select "Device Search."
5. Select "Search Headset."
 - Displays the usable headsets in the pairing list.
6. Select a headset to pair.
 - The confirmation dialog is displayed.
7. Select "YES."
 - After connecting to the headset,  is displayed in the pairing list.

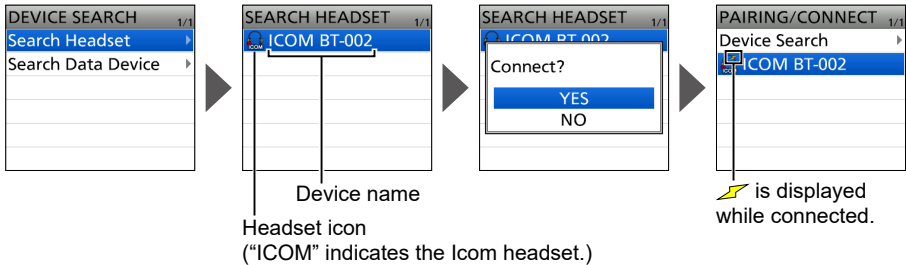

8. To exit the MENU screen, push [MENU].
 - ① While connected to a Bluetooth device, the Bluetooth icon is displayed on the Standby screen.
 - ① When "AF Output" is set to "Headset Only" and the Bluetooth connection is accidentally disconnected, a dialog is displayed to select whether or not to output the audio from the transceiver's speaker.

 is displayed while connected.



TIP:

Auto Connect function

The transceiver automatically connects to a paired Bluetooth device.
 ([MENU] > SET > Bluetooth Set > **Auto Connect**)

Re-searching Bluetooth device

"No Device Found" is displayed if the transceiver could not find a Bluetooth device.

1. Push [QUICK].
2. Select "Re-search."

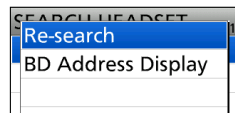



8 Bluetooth® OPERATION

■ Disconnecting a Bluetooth® device

You can disconnect a paired Bluetooth device if it is not being used.

[MENU] > SET > Bluetooth Set > **Pairing/Connect**

1. Push [MENU].
2. Select "Bluetooth Set" in the "SET" menu.
3. Select "Pairing/Connect."
 - Paired devices are displayed.
 - ①  is displayed on the device icon, if the device is connected.
4. Select a device to disconnect.
 - The confirmation dialog is displayed.
5. Select "YES."
 - The transceiver disconnects from the Bluetooth device, and  disappears from the device icon. However, the transceiver is still paired with the device.
 - ① To exit the MENU screen, push [MENU].
 - ① To reconnect a device, select the device on the pairing list again.

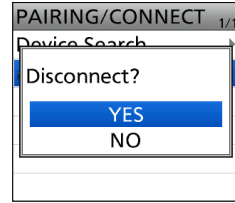

■ Deleting a Bluetooth® device from the pairing list

Before deleting a connected Bluetooth device, disconnect it.

[MENU] > SET > Bluetooth Set > **Pairing/Connect**

1. Push [MENU].
2. Select "Bluetooth Set" in the "SET" menu.
3. Select "Pairing/Connect."
 - Paired devices are displayed.
4. Select a device to unpair, and then push [QUICK].
5. Select "Delete."
 - The confirmation dialog is displayed.
6. Select "YES."
 - ① To exit the MENU screen, push [MENU].
 - ① To connect to a deleted device, you must first pair with it again. (p. 32)

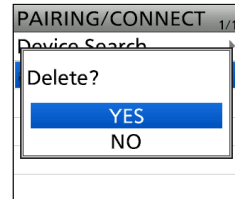
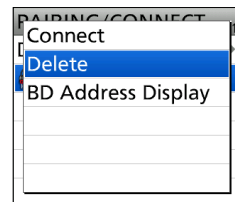

◇ General

- Frequency coverage (unit: MHz):
 - USA version
 - [A band] Receive: 108.000 ~ 174.000 (Guaranteed only 144 ~ 148 MHz)
225.000 ~ 479.000 (Guaranteed only 440 ~ 450 MHz)
 - Transmit: 144.000 ~ 148.000
430.000 ~ 450.000 (Guaranteed only 440 ~ 450 MHz)
 - [B band] Receive: 137.000 ~ 174.000 (Guaranteed only 144 ~ 148 MHz)
375.000 ~ 479.000 (Guaranteed only 440 ~ 450 MHz)
 - Transmit: 144.000 ~ 148.000
430.000 ~ 450.000 (Guaranteed only 440 ~ 450 MHz)
 - [BC band (WFM)]
 - EUR version
 - [A band] Receive: 108.000 ~ 174.000 (Guaranteed only 144 ~ 146 MHz)
225.000 ~ 479.000 (Guaranteed only 430 ~ 440 MHz)
 - Transmit: 144.000 ~ 146.000
430.000 ~ 440.000
 - [B band] Receive: 137.000 ~ 174.000 (Guaranteed only 144 ~ 146 MHz)
375.000 ~ 479.000 (Guaranteed only 430 ~ 440 MHz)
 - Transmit: 144.000 ~ 146.000
430.000 ~ 440.000
 - [BC band (WFM)] Receive: 76.000 ~ 108.000
- Modes: FM/FM-N (F2D/F3E), AM/AM-N(A3E)*, DV (F7W)
* RX only
- The number of Memory channels: 1000 channels (in 100 groups)
- The number of Skip channels: 100 channels
- The number of FM Radio memory channels: 500 channels (in 26 groups)
- The number of Program Scan Edge: 25 channels (2 edge frequencies in each channel)
- The number of Call channels: 4 channels (2 channels × 2 bands)
- Number of repeater memories: 2500 (in 50 groups)
- Number of GPS memories: 300
- Usable temperature range: -20°C ~ +60°C, -4°F ~ +140°F
- Tuning steps: 5, 6.25, 8.33*, 10, 12.5, 15, 20, 25, 30, 50, 100, 125, and 200 kHz
* For only 108.000 MHz ~ 136.991 MHz
- Frequency stability: ±2.5 ppm (-20°C ~ +60°C, -4°F ~ +140°F)
- Power supply: 10.0 ~ 16.0 V DC for external DC power
7.4 V DC specified Icom's battery pack
5.5 V DC specified Icom's battery case
- Current drain (at 7.4 V DC):
 - Transmit (at 5 W) 2.5 A or less
 - Receive (Maximum output, 8 Ω load)
 - FM/FM-N 400 mA or less
 - DV 450 mA or less
- Antenna connector: SMA (50 Ω)
- Dimensions: 61.1 (W) × 121.6 (H) × 29.7 (D) mm,
(projections not included) 2.4 (W) × 4.8 (H) × 1.2 (D) inches
- Weight (approximate): 330 g, 11.6 oz (Including battery pack and antenna)

9 SPECIFICATIONS

◇ Transmitter

- Modulation system:
 - FM/FM-N Variable reactance frequency modulation
 - DV GMSK reactance frequency modulation
- Output power (at 7.4 V DC): High: 5.0 W, Mid: 2.5 W, Low2: 1.0 W, Low1: 0.5 W, S-Low: 0.1 W
- SAR 10g: 5.49 W/kg
- Maximum frequency deviation:
 - FM ± 5.0 kHz or less
 - FM-N ± 2.5 kHz or less
- Spurious emissions:
 - 60 dBc or less at High/Mid
 - 13 dBm or less at Low2/Low1/S-Low
- Microphone impedance: 2.2 k Ω

◇ Receiver

- Receive system: Double Conversion Superheterodyne
- Intermediate frequencies:
 - A band 1st IF 58.05 MHz, 2nd IF 450 kHz
 - B band 1st IF 57.15 MHz, 2nd IF 450 kHz
- Sensitivity:
 - Ham band FM/FM-N 0.18 μ V or less (at 12 dB SINAD)
 - DV 0.2 μ V or less (at 1% BER)

Outside Ham band

| Band | Frequency range (MHz) | FM/FM-N/WFM*1 (12 dB SINAD) | AM/AM-N*2 (10dB S/N) |
|---------|-----------------------|-----------------------------|----------------------|
| BC band | 76.000 ~ 108.000 | 1 μ V or less | - |
| A band | 108.000 ~ 136.991 | - | 1 μ V or less |
| | 137.000 ~ 142.000 | 0.18 μ V or less | 1 μ V or less |
| | 142.005 ~ 148.000 | 0.18 μ V or less | - |
| | 148.005 ~ 174.000 | 0.32 μ V or less | - |
| | 225.000 ~ 259.995 | 0.56 μ V or less | 1.8 μ V or less |
| | 260.000 ~ 354.995 | 0.32 μ V or less | 1 μ V or less |
| | 355.000 ~ 374.995 | 0.5 μ V or less | 1.8 μ V or less |
| | 375.000 ~ 399.995 | 0.5 μ V or less | - |
| B band | 400.000 ~ 479.000 | 0.32 μ V or less | - |
| | 137.000 ~ 148.000 | 0.18 μ V or less | - |
| | 148.005 ~ 174.000 | 0.32 μ V or less | - |
| | 375.000 ~ 399.995 | 0.5 μ V or less | - |
| | 400.000 ~ 479.000 | 0.32 μ V or less | - |

*1 "WFM" is for only BC band. "FM" and "FM-N" is for only A/B band.

*2 "AM-N" is for only 108.000 MHz ~ 143.995 MHz.

- Audio output power:
 - Internal speaker 0.75 W or more at 10% distortion into an 8 Ω load
 - External speaker 0.2 W or more at 10% distortion into an 8 Ω load
- Selectivity:
 - FM 55 dB or more
 - FM-N/DV 50 dB or more

◇ Receiver

- Spurious and image rejection ratio:
60 dB or more
- Squelch Sensitivity:
Ham band 0.18 μV or less (threshold)
Outside Ham band

| Band | Frequency range (MHz) | FM/FM-N/WFM*1 | AM/AM-N*2 |
|---------|-----------------------|-----------------|----------------|
| BC band | 76.000 ~ 108.000 | 1.8 μV or less | – |
| A band | 108.000 ~ 136.991 | – | 1 μV or less |
| | 137.000 ~ 142.000 | 0.32 μV or less | 1 μV or less |
| | 142.005 ~ 148.000 | 0.32 μV or less | – |
| | 148.005 ~ 174.000 | 0.32 μV or less | – |
| | 225.000 ~ 259.995 | 0.56 μV or less | 1.8 μV or less |
| | 260.000 ~ 374.995 | 0.32 μV or less | 1 μV or less |
| | 375.000 ~ 399.995 | 0.32 μV or less | – |
| B band | 400.000 ~ 479.000 | 0.32 μV or less | – |
| | 137.000 ~ 148.000 | 0.32 μV or less | – |
| | 148.005 ~ 174.000 | 0.32 μV or less | – |
| | 375.000 ~ 399.995 | 0.32 μV or less | – |
| | 400.000 ~ 479.000 | 0.32 μV or less | – |

*1 “WFM” is for only BC band. “FM” and “FM-N” is for only A/B band.

*2 “AM-N” is for only 108.000 MHz ~ 143.995 MHz.

◇ Bluetooth

- Version: Bluetooth Version 5.3
- Transmission Output: Class 1
- Profile: HFP, HSP, SPP, GATT (Serial) over LE
- The maximum number of paired Bluetooth devices:
7 devices
① Maximum headsets or data devices are 4 devices each, and the maximum combination is 5 devices in total. Maximum Bluetooth Low Energy devices are 2 devices.
- Device Name: ICOM BT(ID-52) (at default)
- Passkey: 0000 (four zeros)

Fuse Coding explanation

| | OPC-254L (Option) | CP-12L (Option) |
|---------------------|-------------------|-----------------|
| Fuse Coding | FUSE 250V 3A | FUSE 125V 3A |
| Fuse Voltage Rating | 250 Volts | 125 Volts |
| Fuse Current Rating | 3 Amperes | 3 Amperes |

① All stated specifications are typical and subject to change without notice or obligation.

10 MAINTENANCE

■ Resetting

Occasionally, erroneous information is displayed when, for example, first applying power. This may be caused externally by static electricity or by other factors.

If this problem occurs, perform a Partial reset or an All reset.

BE CAREFUL! An All reset clears all programming and returns all settings to the factory defaults. See the Advanced manual for details.

After performing an All reset, you cannot use the DR function because the Repeater List contents are also cleared.

◇ Partial Reset

[MENU] > SET > Others > Reset > **Partial Reset**

1. Push [MENU].
2. Select "Others" in the "SET" menu.
3. Select "Reset."
4. Select "Partial Reset."
 - The confirmation dialog is displayed.
5. Select "YES."
 - "PARTIAL RESET" is displayed, and then the display automatically returns to the default screen.

TIP: A Partial Reset resets the operating settings to their defaults without clearing the following:

- | | | |
|---------------------------|-------------------------|-------------------------|
| • Memory Channel contents | • Call Channel contents | • Radio Memory contents |
| • Scan Edge contents | • Message data | • GPS memory contents |
| • Call sign memories | • DTMF memory contents | • Repeater list |
| • Bluetooth pairing list | • Opening picture | |

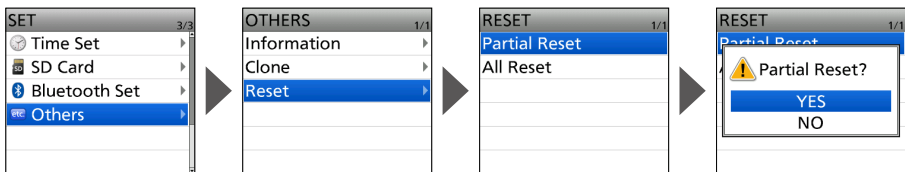

■ Troubleshooting

The following chart is designed to help you correct problems that are not equipment malfunctions.

If you are unable to locate the cause of a problem or solve it through the use of this chart, contact your nearest Icom Dealer or Service Center.

① “AM” indicates the PDF type Advanced Manual.

Transceiver does not turn ON.

- The battery is exhausted.
 - Charge the battery pack, or replace the batteries. (p. 6)
- Loose the connection of a battery pack (case).
 - Clean the battery terminals.
- The battery polarity in the battery case is reversed.
 - Check the battery polarity in the case.

No sound comes from the speaker.

- The volume level is too low.
 - Rotate [VOL] to adjust the level. (p. 7)
- The squelch level is too high.
 - Adjust the squelch level. (p. 12)
- The tone or digital squelch function is turned ON.
 - Turn OFF the tone or digital squelch function. (AM)
- An external speaker is connected to the [SP] jack.
 - Check the external speaker connection.
- A Bluetooth device is connected.
 - Disconnect the device. (p. 33)

“✖” is displayed.

- You select a memory channel that is out of the selectable frequency range on the B band.
 - Select the memory channel on the A band. (p. 11)
- “Sub Band Mute” is set to “Mute” or “Mute & Beep.”
 - Set the “Sub Band Mute” to “OFF” or “Beep.”

Sensitivity is too low, and only strong signals are heard.

- The coaxial cable is not connected or shorted (External antenna is used).
 - Check the coaxial cable connection or replace it with a new one.
- The Attenuator function is turned ON.
 - Turn OFF the attenuator. (p. 16)

No reply is received after a call.

- The duplex function is set, the receive and transmit frequencies are different.
 - Set for simplex operation. (AM)
- No station is in range or on the same frequency.
 - Wait for a while, and try again.

Frequency cannot be set.

- The Key Lock function is activated.
 - Cancel the Key Lock function. (p. 20)
- The VFO mode is not selected.
 - Push [VFO/MHz] to select the VFO mode. (p. 14)

The displayed frequency is erroneous.

- The CPU has malfunctioned.
 - Reset the transceiver. (p. 37)
- External factors have caused a fault.
 - Remove and reattach the battery pack/case. (p. 5)

Transmitting is impossible.

- The transmit power level is set to S-Low, Low1, Low2, or Mid.
 - Set the transmit power level to High. (p. 19)
- The PTT Lock function is activated.
 - Turn OFF the PTT Lock function on the MENU screen. (p. 73)
- The Busy Lockout function is activated.
 - Turn OFF the Busy Lockout function on the MENU screen. (p. 73)
- The transmit frequency is out of the amateur radio band.
 - Set the transmit frequency within the amateur radio band. (p. 18)

10 MAINTENANCE

■ Troubleshooting

① “AM” indicates the PDF type Advanced Manual.

A Program Scan does not start.

- The VFO mode is not selected.
 - Push [VFO/MHz] to select the VFO mode. (p. 14)
- The same frequencies are entered into the scan edges.
 - Enter different frequencies into the scan edges. (AM)

“No SD Card is found.” is displayed.

- A microSD card is not recognized.
 - Confirm that a microSD card is inserted.
 - Reinsert a microSD card. (p. 7)
 - Exchange with a new microSD card. (p. 25)

A Memory Scan does not start.

- The Memory mode is not selected.
 - Push [MR] to select the Memory mode. (p. 14)
- Only one or no memory channel is entered.
 - Enter two or more memory channels. (p. 23)

A distorted noise is heard when the earphone is used.

- The earphone mode is OFF.
 - Turn ON the earphone mode on the MENU screen. (p. 74)

Charging is impossible at power ON.

- “Charging (Power ON)” is set to “OFF.”
 - Set “Charging (Power ON)” to “ON” (default) on the MENU screen.* (p. 73)
 - * This operation may generate certain spurious signals, the S-meter appears, or noise may be heard.

Failed to Bluetooth pairing.

- The Bluetooth device is not in the Pairing mode.
 - Confirm the Bluetooth device is in the Pairing mode, and then try again. (p. 32)
- There are other active Bluetooth devices nearby.
 - Stop using other Bluetooth devices.
 - Use the transceiver away from other Bluetooth devices.
- There are other devices that are operating in the 2.4 GHz band.
 - Use the transceiver away from the other devices, or stop using those devices.

D-STAR GUIDE

for the ID-52A PLUS/ID-52E PLUS

INTRODUCTION

■ Unique features of D-STAR

- Easy Cross band operation through the repeater!

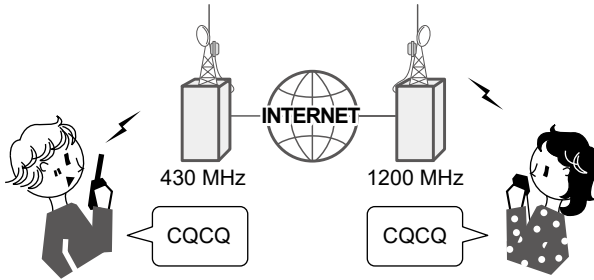

- Easy call sign entry with the Repeater list or TX/RX History!

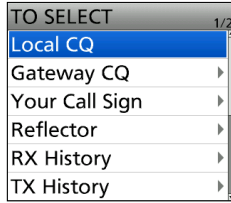

- The Call Sign Capture key [RX>CS] makes call sign capture easy!

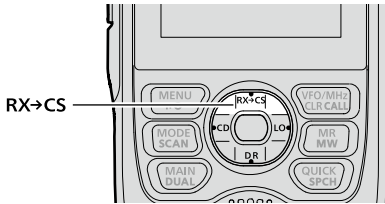

■ What is D-STAR?

- D-STAR is a digital protocol standard developed by the Japan Amateur Radio League (JARL). The system includes the DV mode for Digital Voice and the DD mode for Digital Data communications.
- D-STAR supports the DV mode at 4.8 kbps. Your call sign data, and either a short message, or GPS data can be transmitted simultaneously with your voice signal.
- D-STAR supports a comprehensive repeater system linked through the Internet, enabling you to make QSOs with stations near or far from your location.

Advanced Amateur radio technology of D-STAR

The DV mode has a bandwidth of only 6 kHz, compared to 16 kHz for the analog FM mode, with 5 kHz deviation. D-STAR utilizes the well-know GMSK modulation method that makes very efficient use of occupied bandwidth.

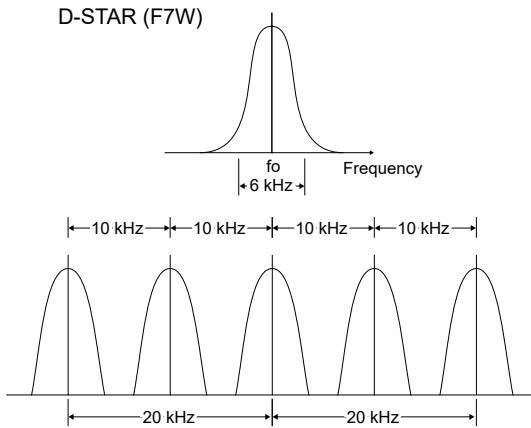

D-STAR occupies 10 kHz. The sound quality is good even though the bandwidth is narrow.

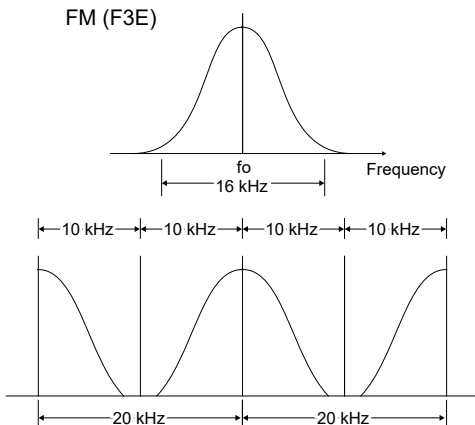

The regular FM mode occupies 20 kHz that is double the bandwidth of D-STAR.

INTRODUCTION

IMPORTANT! Before starting D-STAR, the following steps are needed.
STEP 1. Enter your call sign (MY) into the transceiver. (p. 45)
STEP 2. Register your call sign (MY) to a gateway repeater. (p. 47)
STEP 3. Enter your D-STAR equipment into your registration form. (p. 48)

► **You have completed the steps!!**

■ About the DR function

You can easily use D-STAR repeaters with the D-STAR Repeater (DR) function. With this function, you can select the preset repeater or frequency in “FROM” (access repeater), and Your call sign in “TO” (destination) on the DR screen, as shown below.

- To display the DR screen, hold down [DR] for 1 second.
- On the DR screen, pushing D-pad(↓) selects “FROM” and pushing D-pad(↑) selects “TO.”

NOTE: If the repeater set in “FROM” (Access Repeater) has no Gateway, you cannot make a Gateway call.

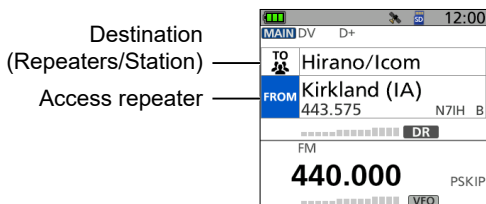

The DR screen (Example)

■ Ways to Communicate with the DR function

With the DR function, the transceiver has 3 ways to communicate.

Local Area call: To call through your local area (access) repeater.

① You can use an FM repeater.

Gateway call: To call through your local area (access) repeater, repeater gateway, and the Internet to your destination repeater or individual station's last used repeater, using Call Sign Routing.

Simplex call*: To call another station not using a repeater.

* You can make a simplex call in the VFO mode. (p. 50)

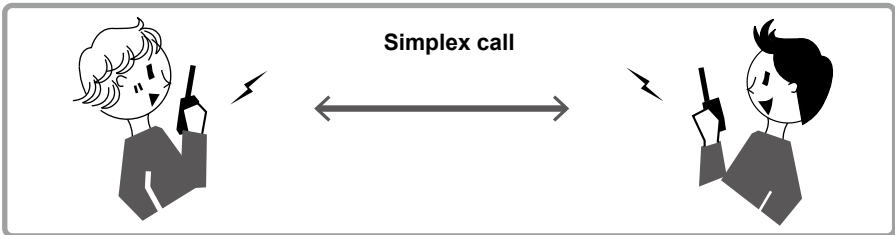
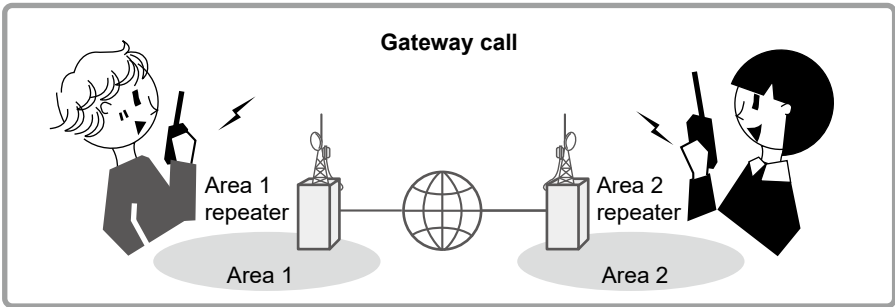
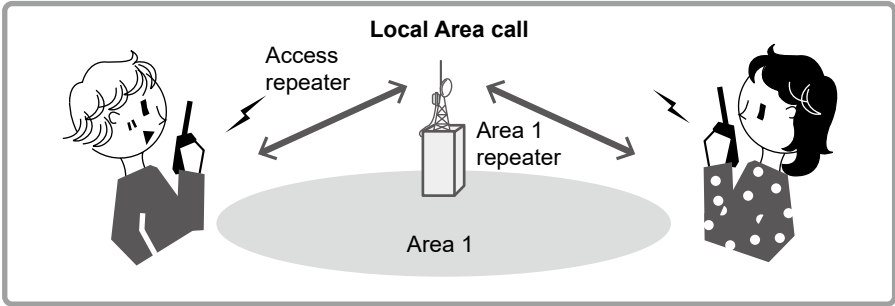

NOTE:

- Using the repeater list is required to use the DR function. (p. 66)
- Before operating in the Duplex mode, **BE SURE** to check whether the repeater is busy, or not. If the repeater is busy, wait until it is clear, or ask for a 'break' using a method acceptable to your local procedures.
- The transceiver has the Time-Out Timer function for the DV Repeater operation. The timer limits a continuous transmission. Warning beeps will sound approximately 30 seconds before timeout and then again immediately before the time-out.

INTRODUCTION

■ Enter your call sign (MY) into the transceiver

To operate D-STAR, you must first enter your call sign into the MY call sign memory. You can enter up to 6 MY call signs.

NOTE:

- Your MY call sign must match the call sign registered on a gateway repeater. (p. 47)
- The MY Call sign in the instructions is ONLY an example that is used in explanations. You MUST enter your own call sign, the one that was assigned to you and is on your license.

Example: Enter “JA3YUA” as your own call sign into “MY1.”

Step 1: Display the MY CALL SIGN edit screen

[MENU] > SET > My Station > **My Call Sign**

1. Push [MENU].
2. Select “My Station” in the “SET” menu.
3. Select “My Call Sign.”
4. Select MY call sign memory, then push [QUICK]. (Example: “1.”)
5. Select “Edit.”
 - Displays the MY CALL SIGN edit screen.

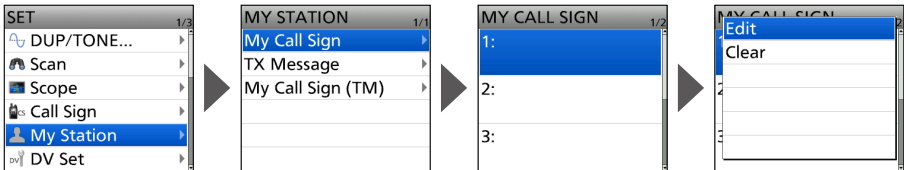

Step 2: Enter and set your own call sign

1. Enter your own call sign, then push [ENT].
 - ① See “How to enter characters” on the right page.
2. Select the entered call sign, then push [ENT].
 - Sets the call sign to be used as MY call sign.
 - ① To exit the MENU screen, push [MENU].

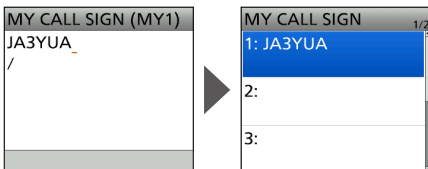

How to enter characters:

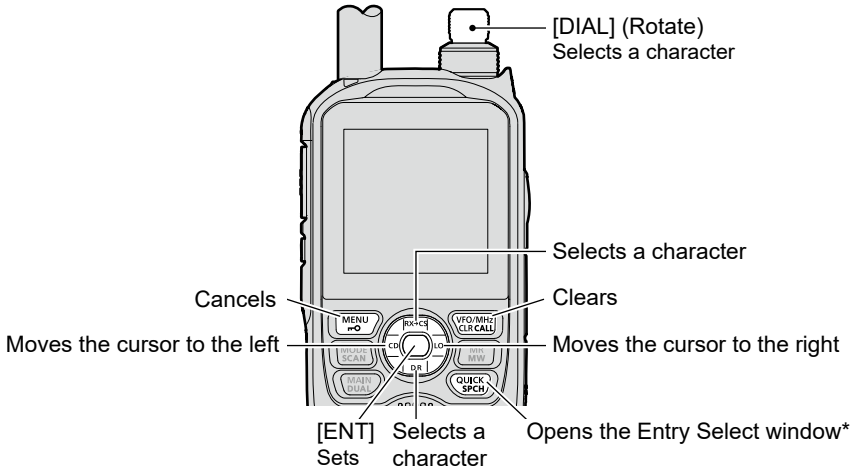

- Continuously holding down [CLR] clears characters.
- Push [QUICK] to display the Entry Mode Select window.*
In the Entry Mode Select window, rotate [DIAL] to select an entry mode, then push [ENT].
- * You cannot change the entry mode in the MY CALL SIGN edit screen.

TIP: You can enter a note of up to 4 characters, such as the model of the transceiver, name, area name, after your call sign.

1. After entering a call sign, push D-pad(→) several times until the cursor moves to the right of the “/.”
2. Enter a 4 character note. (Example: ID52)

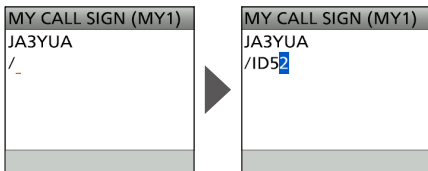

INTRODUCTION

■ Register your call sign at a gateway repeater

To make a Gateway call through the Internet, you must register your call sign at a repeater that has a gateway, usually one near you.

About the registration process described:

This section describes the call sign registration process at a repeater that is connected to the US Trust server. There are other systems as well, and they have their own registration process. For information on how to register on one of them, contact the administrator of a repeater that uses the alternate system.

NOTE: If needed, ask the gateway repeater administrator for call sign registration instructions.

Step 1: Access the call sign registration screen

1. Access the following URL to find the gateway repeater closest to you.
<https://www.dstarusers.org/repeaters.php>
2. Click the call sign of the repeater that you want to register to.
3. Click the “Gateway Registration URL.” link address.
4. The “D-STAR Gateway System” screen is displayed.
Click <Register> to start the New User registration.

(Sample)

Step 2: Register your call sign

1. Follow the registration instructions found there.
2. When you receive a notification from the administrator, your call sign registration has been approved.

NOTE: It may take a few days for the administrator to approve you.

Step 3: Register your personal information

After your registration is approved, log in your personal account with your registered call sign and password.

REVISION

D-STAR Gateway System (日本語)

Already registered?
 Login with Callsign and Password
 Please note that Callsign and Password are case sensitive!
 Callsign must be in Upper Case!

CallSign:

Password:

Click

New user?
 Register here for D-STAR access.
 Registering takes just a few seconds, and
 you won't have to enter your personal information
 again the next time you visit here.

D-STAR is a digital protocol developed by the Japan Amateur Radio League (the JARL)
 and stands for **Digital Smart Technology for Amateur Radio**.

(Sample)

Step 4: Register your D-Star equipment

1. Register your D-STAR equipment information. Ask the gateway repeater administrator for details.
2. When your registration is complete, log out of your personal account, and start using the D-STAR network.

NOTE: You must register your D-STAR equipment **BEFORE** you make Gateway Repeater calls.

D-STAR OPERATION

■ Making a Simplex call

This section describes the simplex operation (through no repeater).

NOTE: The frequencies may be different, depending on the transceiver's version. Check for usable frequencies for your operating area.

What is a Simplex Call?

A simplex call is a direct call to another station on a single frequency, not using a repeater.

Example: Making a simplex call on 445.670 MHz.

Step 1: Set "FROM" (Simplex channel).

1. Push D-pad(↓) to select "FROM," and then push [ENT].
 2. Select "Repeater List."
 3. Select a "Simplex" group.
 4. Select a frequency.
 - Returns to the DR screen, and the selected frequency is displayed in "FROM."
 - "CQCQCQ" is displayed in "TO."
- ① If a station call sign is set in "TO," select "Local CQ" in the TO SELECT screen.

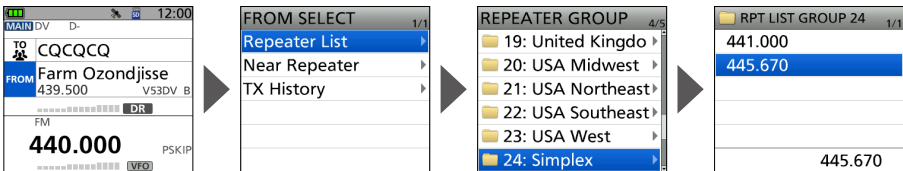

Step 2: Hold down [PTT] to transmit.

1. Hold down [PTT] to transmit.
 - The TX/RX indicator lights red while transmitting.
2. Release [PTT] to receive.

TIP: You can change the simplex frequencies on the MENU screen. ([MENU] > MEMORY > **Repeater List**) See the Advanced manual for details.

To make a Simplex call in the VFO mode

1. Push [VFO/MHz] to enter the VFO mode.
2. Rotate [DIAL] to set the operating frequency. (p. 16)
3. Push [MODE] to set the operating mode to DV.
4. Hold down [LO] for 1 second to set an output power. (p. 19)
5. Hold down [PTT] to transmit, and speak into the microphone at your normal voice level.
 - The TX/RX indicator lights red while transmitting.
 - The S/Rf meter displays the output power level.
6. Release [PTT] to receive.



① If you enter a DV simplex frequency to a Memory channel, you can also make a simplex call in the Memory mode. See page 23 on how to enter Memory channels.

D-STAR OPERATION

■ Accessing repeaters

This section describes how to check whether or not you can access your local area repeater (access repeater), and your signal is successfully sent to a destination repeater.

TIP: If your call sign (MY) has not been set, or your call sign and D-STAR equipment have not been registered at a D-STAR repeater, see pages 45 ~ 48.

Step 1: Set "FROM" (Access repeater).

1. Push D-pad(↓) to select "FROM," and then push [ENT].
2. Select "Repeater List."
3. Select the repeater group where your access repeater is listed.
4. Select your access repeater.
 - Returns to the DR screen, and the selected repeater name is displayed in "FROM."
 - ① By just selecting the repeater name, the repeater call sign, its frequency, duplex setting, and frequency offset are automatically set.
 - ① A repeater list here is just an example.

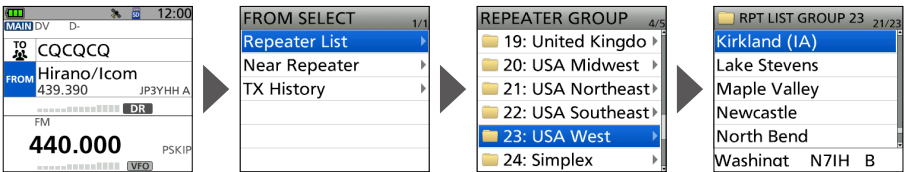

TIP: There are several ways to set your access repeater. (p. 63)

- Setting by [DIAL]
- Searching for a repeater using the DR scan
- Searching for the nearest repeater
- Setting from the TX History

Step 2: Set "TO" (Destination).

1. Push D-pad(↑) to select "TO," and then push [ENT].
2. Select "Gateway CQ."
3. Select the repeater group where your destination repeater is listed.
4. Select your destination repeater.
 - Returns to the DR screen, and the selected repeater name is displayed in "FROM."

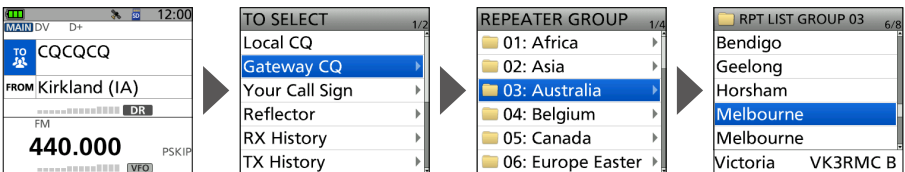

Step 3: Check whether you can access the repeater.

Hold down [PTT] for 1 second to access the repeater.

- ① If you get a reply call, or “UR?” is displayed within 3 seconds, your signal reached your access repeater and your call was successfully sent from your destination repeater.

TIP: See page 65 for status indications after a reply is received.



UR?: N7IH B

Successfully sent!

D-STAR OPERATION

■ Receiving

When a DV call is received, the call signs of the caller, the called station, and the called station's access repeater are saved in the RX History. Up to 50 calls can be saved.

Even if you turn OFF the transceiver, the RX History is retained.

This section describes how to display the RX History screen and how to save the call sign to your memory.

When receiving a call from "JM1ZLK":



The S-meter and the caller's call sign are displayed.

Step 1: Display a received call sign.

1. Hold down [CD] for 1 second.
 - Displays the RX HISTORY screen.
2. Push D-pad(↑).
 - Displays other RX history records.

RX HISTORY screen (LAST(MAIN))

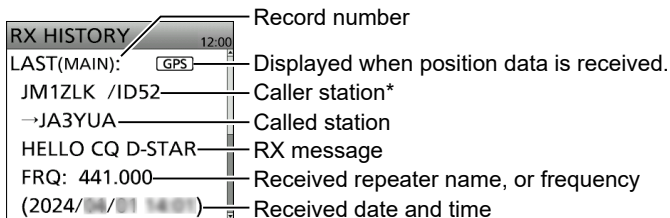

* The caller name is displayed when the name is set in the "Your Call Sign" list.

Push [QUICK] to switch between name display and call sign display.

- ① "/" and a note may be displayed after the call sign.
- ① If a call is received from an area, not from a specific station, "CQCQCQ" is displayed.

Step 2: Save the destination call sign into your call sign memory from RX History.

1. Push D-pad(↓) to select the RX HISTORY record with the call sign that you want to save to memory.
2. Push [ENT].
 - Displays the RX HISTORY DETAIL screen.
3. Push [QUICK].
4. Select “Add To Your Memory.”
5. Select the call sign that you want to save.
6. Select “NAME.”
7. Enter a name of up to 16 characters, then push [ENT].
 - ① Usable characters are A to Z, a to z, 0 to 9, ! “ # \$ % & ’ () * + , - . / : ; < = > ? @ [\] ^ _ ` { | } ~ (space).
 - ① See “How to enter characters.” (p. 46)
8. Select “<<Add Write>>.”
 - The confirmation dialog “Add write?” is displayed.
9. Select “YES.”
 - The call sign is added to your memory, and returns to the RX HISTORY screen.
 - ① To exit the screen, push [MENU].

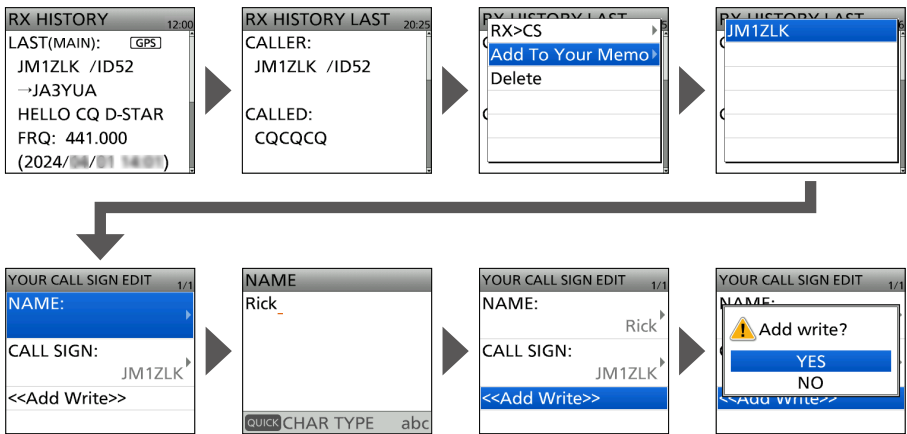

D-STAR OPERATION

■ Capturing a call sign

After you receive a signal, the calling station's call sign can be captured by holding down the Call Sign Capture key ([RX→CS]) for 1 second. After releasing, you can quickly and easily reply to the call.

What is the Call Sign Capture key?

Holding down the Call Sign Capture key for 1 second sets the last received station's call sign as a temporary destination, and makes replying quick and easy.

Step 1: Set the received call sign to "TO" (Destination).

While receiving, hold down [RX→CS] for 1 second.

- After releasing the key, the transceiver announces the station call sign, and the call sign is captured.

① Information

- If you want to select another call sign in the RX History, rotate [DIAL] while holding down [RX→CS].
- You can change the setting of the [RX→CS] key on the MENU screen. If "[RX→CS] Key" is set to "RX > CS List," the received call sign is not captured. The RX History list is displayed instead. ([MENU] > SET > DV Set > [RX>CS] Key)
- When a received signal is weak, or during a DV scan, the call sign may not be correctly received. In that case, you cannot capture the call sign.
- When "RX > CS SPEECH" is set to "OFF," the transceiver does not announce the call sign. (MENU > SET > SPEECH > RX > CS SPEECH)



While holding down

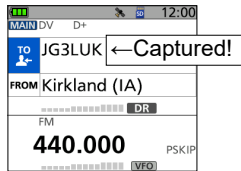

After releasing

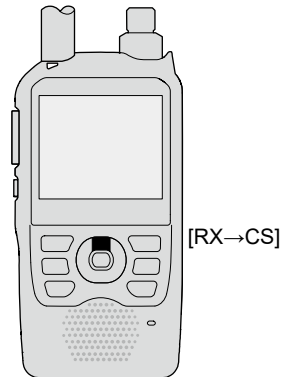

Step 2: Hold down [PTT] to transmit.

1. Hold down [PTT] to transmit.
 - The TX/RX indicator lights red while transmitting.
2. Release [PTT] to receive.
 - ① Push [RX→CS] to return to the previous call sign setting.

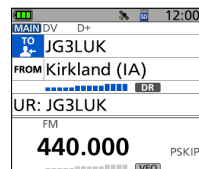

■ Making a Local CQ call

You can make a Local CQ call when “Local CQ” is set to “TO” (Destination).

What is a Local CQ Call?

To call a CQ through only your local area (access) repeater.

Step 1: Set “FROM” (Access repeater).

1. Push D-pad(↓) to select “FROM,” and then push [ENT].
2. Select “Repeater List.”
3. Select the repeater group where your access repeater is listed.
4. Select your access repeater.
 - Returns to the DR screen, and the selected repeater name is displayed in “FROM.”

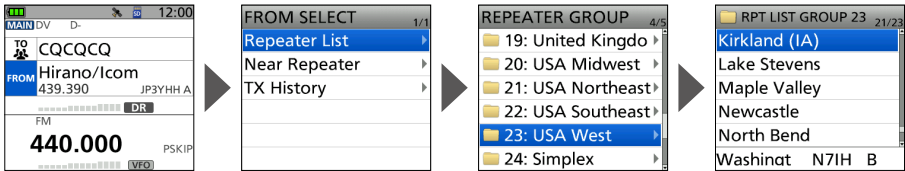

Step 2: Set “TO” (Destination).

1. Push D-pad(↑) to select “TO,” and then push [ENT].
2. Select “Local CQ.”
 - Returns to the DR screen, and “CQCQCQ” is displayed in “TO.”

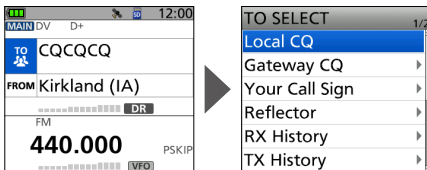

Step 3: Hold down [PTT] to transmit.

1. Hold down [PTT] to transmit.
 - The TX/RX indicator lights red while transmitting.
2. Release [PTT] to receive.

TIP: The Local CQ call is used to call anyone, but you can call a specific station by simply saying their call sign.

D-STAR OPERATION

■ Making a Gateway CQ call

You can make a Gateway CQ call when a destination repeater is selected in “TO” (Destination).

What is a Gateway CQ call?

- To call a CQ through a repeater connected to the Internet.
- You can call a CQ to the areas where you cannot directly access because the communication is routed through the Internet.

Step 1: Set “FROM” (Access repeater).

- ① Same as described in page 56.

Step 2: Set “TO” (Destination).

1. Push D-pad(1) to select “TO,” and then push [ENT].
2. Select “Gateway CQ.”
3. Select the repeater group where your destination repeater is listed.
4. Select your destination repeater.
 - Returns to the DR screen, and the selected repeater name is displayed in “TO.”

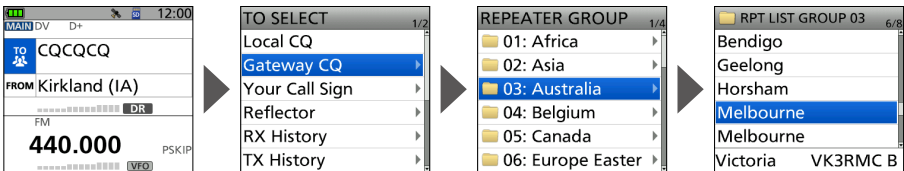

Step 3: Hold down [PTT] to transmit.

1. Hold down [PTT] to transmit.
 - The TX/RX indicator lights red while transmitting.
2. Release [PTT] to receive.

NOTE: If the selected Access repeater does not connect to the gateway, “XGW” is displayed. In that case, you cannot select “Gateway CQ.”

■ Calling an individual station

You can make a call to an individual station when the station call sign is selected in “TO” (Destination).

When you call an individual station through a gateway, your call is automatically sent to the last repeater that the station accessed. So, even if you don’t know where the station is, you can make a call using Call Sign Routing.

Step 1: Set “FROM” (Access repeater).

① Same as described in page 56.

Step 2: Set “TO” (Destination).

1. Push D-pad(↑) to select “TO,” and then push [ENT].
2. Select “Your Call Sign.”
3. Select your destination station.
 - Returns to the DR screen, and the selected station name is displayed in “TO.”

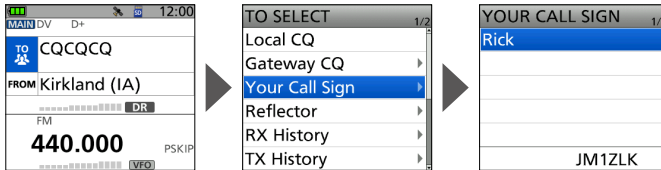

Step 3: Hold down [PTT] to transmit.

1. Hold down [PTT] to transmit.
 - The TX/RX indicator lights red while transmitting.
2. Release [PTT] to receive.

D-STAR OPERATION

■ About reflectors

◇ What is a reflector?

A reflector is a special server connected to the Internet and running a version of the D-Plus software. If the D-Plus software is installed on your Access repeater, it provides various functions including gateway and reflector linking capabilities (It is known as the D-STAR reflector system). The D-STAR reflector system enables a number of D-STAR repeaters anywhere to link to a reflector. This means that when you transmit through a D-STAR repeater linked to a reflector, your voice can be heard on other repeaters linked to the reflector, and you can hear other stations that are connected to the reflector.

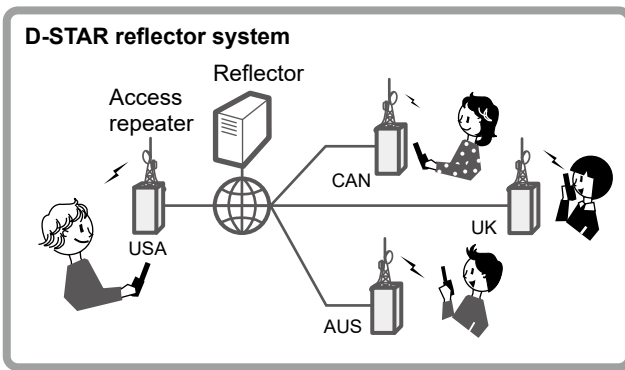

◇ Unlinking a reflector

Before trying to link to another reflector, **BE SURE** to unlink the reflector that is currently connected to the repeater.

NOTE: If a reflector is already connected, ask on the air whether or not you can change reflectors and wait for responses. **BE SURE** to reconnect back to the same reflector when you finish your conversation.

1. Push D-pad(1) to select "TO," and then push [ENT].
2. Select "Reflector."
3. Select "Unlink Reflector."
 - Returns to the DR screen, and "Unlink Reflector" and "U" are displayed in "TO."
4. Hold down [PTT] to unlink the reflector.
 - The TX/RX indicator lights red.

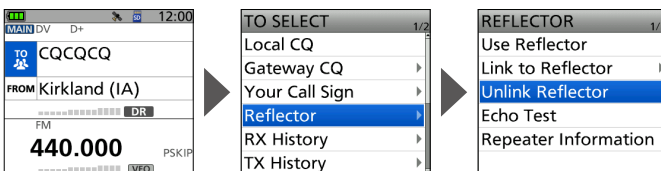

◇ Linking to a reflector

If your repeater is not currently linked to a reflector, or if you want to change it to another reflector, follow the steps below. Before linking to another reflector, **BE SURE** to unlink the current reflector. (p. 59)

Direct inputting a reflector

Example: Directly enter “REF030CL.”

1. Push D-pad(↑) to select “TO,” and then push [ENT].
2. Select “Reflector.”
3. Select “Link to Reflector.”
4. Select “Direct Input.”
5. Push D-pad(↔) to move the cursor, and rotate [DIAL] to select the reflector type, reflector number, or module letter.
6. Push [ENT].
 - Returns to the DR screen, and “Link to Reflector” and entered reflector are displayed in “TO.”
7. Hold down [PTT] to link to the reflector.
 - The TX/RX indicator lights red.

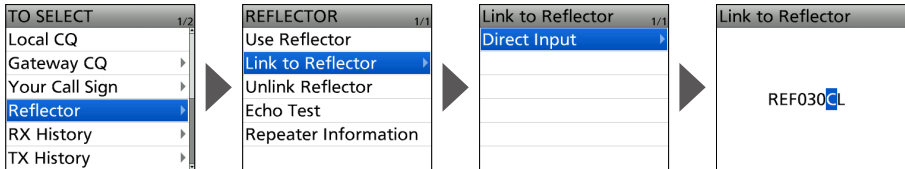

Using the TX History

The TX History saves up to 5 reflectors that your Access repeater linked before.

Example: Select the “REF030CL” in the TX History.

1. Push D-pad(↑) to select “TO,” and then push [ENT].
2. Select “Reflector.”
3. Select “Link to Reflector.”
4. Select the reflector that you want to link to.
 - Returns to the DR screen, and “Link to Reflector” and “REF030CL” are displayed in “TO.”
5. Hold down [PTT] to link to the reflector.
 - The TX/RX indicator lights red.

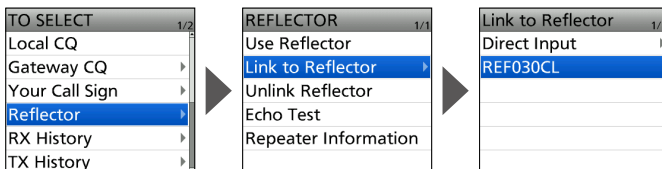

D-STAR OPERATION

■ About reflectors

◇ Using a reflector

1. Push D-pad(1) to select "TO," and then push [ENT].
2. Select "Reflector."
3. Select "Use Reflector."
 - Returns to the DR screen, and "Use Reflector" and "CQCQCQ" are displayed in "TO."
4. Hold down [PTT] to transmit.
 - The TX/RX indicator lights red.
5. Release [PTT] to receive.

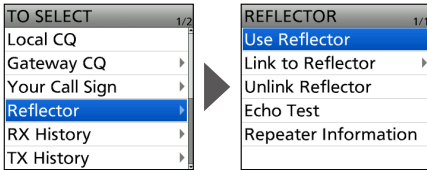

◇ Reflector Echo Testing

To confirm that your signal is correctly getting into the repeater, you can transmit a short message as a trial. After releasing [PTT], your message will be played back.

1. Push D-pad(↑) to select “TO,” and then push [ENT].
2. Select “Reflector.”
3. Select “Echo Test.”
 - Returns to the DR screen, and “Echo Test” and “E” are displayed in “TO.”
4. Hold down [PTT] and speak into the microphone.
 - The TX/RX indicator lights red.
5. Release [PTT] to hear your message.

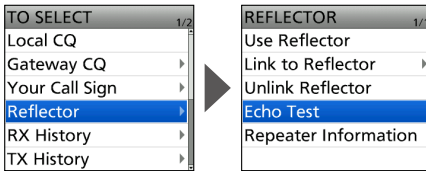

◇ Requesting repeater information

When you send the repeater information command, an ID message is sent back.

1. Push D-pad(↑) to select “TO,” and then push [ENT].
2. Select “Reflector.”
3. Select “Repeater Information.”
 - Returns to the DR screen, and “Repeater Information” and “I” are displayed in “TO.”
4. Hold down [PTT] to transmit the repeater information command.
 - The TX/RX indicator lights red.
5. Release [PTT] to hear the repeater ID message.

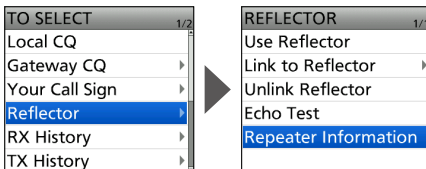

■ “FROM” (Access repeater) setting

By rotating [DIAL]:

Select a preset repeater by rotating [DIAL] on the DR screen.

When you know your access repeater:

From the repeater list:

When your access repeater is in your transceiver’s repeater list, you can select it by selecting the repeater area and name, if entered, or call sign.

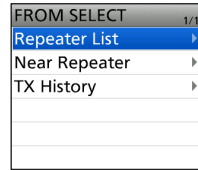

When you do not know which repeater you can access:

Search for a repeater using the DR scan:

The Normal DR scan searches for output repeater frequencies or simplex signals. You can also find FM repeaters.

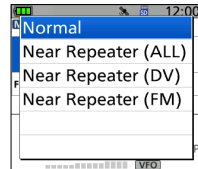

Search for the nearest repeater:

The transceiver searches for the nearest repeater by using your location and the repeater’s location, if it is entered in the Repeater List.

The nearest repeaters in your transceiver’s Repeater List are displayed as selectable choices.

You can select a nearby DV or FM repeater type.

① You can change only the nearest repeater by rotating [DIAL].

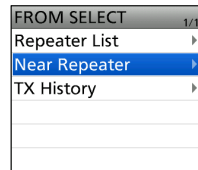

When the “FROM” data is saved in the TX History:

Select from the TX History:

Select a repeater that you have accessed before, from the TX History record.

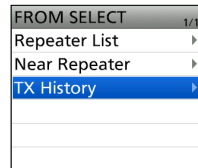

■ “TO” (Destination) setting

By rotating [DIAL]:

Select a repeater or Your Call Sign that is displayed by rotating [DIAL] on the DR screen. (This operation is disabled when “CQCQCQ” is set.)

TIP: After you receive the individual station or repeater’s signal, the call sign can be captured by holding down the Call Sign Capture key ([RX→CS]), and you can quickly and easily reply to a call.

To make a Local Area CQ call:

Set “CQCQCQ” in “TO” (Destination).

To make a Gateway CQ call:

Select a repeater from the repeater list, if you want to make a Gateway call.

To make a call to a specific station:

Select the station call sign in the Your Call Sign.

To make a call through a reflector:

Select a reflector that is connected to the repeater you want to call through.

To select from RX History:

When you receive a call, the caller station data is saved in RX History. You can select the destination from the record.

To select from TX History:

When you make a call, the destination repeater or called station data is saved in TX History. You can select the destination from the record.

To directly enter the destination station call sign:

Directly enter the destination station’s call sign.

To directly enter the destination repeater call sign:

Directly enter the destination repeater’s call sign.

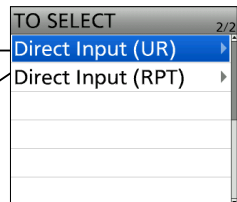
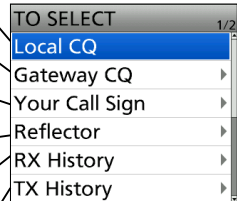

■ When receiving no reply

To communicate through the repeater, your signal must access to the repeater. The following chart is designed to help you correct problems which are not equipment malfunctions.

① “AM” indicates the PDF type Advanced manual.

| PROBLEM | POSSIBLE CAUSE | SOLUTION | REF. |
|---|---|---|-------|
| After your call, the repeater does not return a status reply. | The repeater setting is wrong. | Select the correct repeater. | p. 51 |
| | | Correct the repeater frequency, frequency offset, or duplex settings. | — |
| | Your transmission did not reach the repeater. | Wait until you are closer to the repeater and try again. | — |
| | | Try to access another repeater. | — |
| After your call, the repeater replies ‘UR?’ and its call sign. | The call was successfully sent, but no station immediately replied. | Wait for a while, and try again. | — |
| After your call, the repeater replies ‘RX’ or ‘RPT?’ and the access repeater’s call sign. | Your own call sign (MY) has not been set. | Set your own call sign (MY). | p. 45 |
| | Your own call sign (MY) has not been registered on a gateway repeater, or the registered contents do not match your transceiver’s settings. | Register your own call sign (MY) on a gateway repeater, or confirm the registration of the call sign. | p. 47 |
| After your call, the repeater replies ‘RPT?’ and the access repeater’s call sign. | The call sign of the destination repeater is wrong. | Correctly set the destination repeater call sign. | — |
| After your call, the repeater replies ‘RPT?’ and the destination repeater’s call sign. | The repeater cannot connect to the destination repeater. | Check the repeater settings. | — |
| | The repeater is busy. | Wait for a while, and try it again. | |
| Even holding down [DR], the DR screen is not displayed. | There is no repeater list in your transceiver. | Import the repeater using a microSD card. | p. 66 |
| | | Directly enter the Repeater list data into the transceiver. | AM |
| | The Lock function is activated. | Hold down [LOCK] for 1 second to turn OFF the Lock function. | p. 20 |

| PROBLEM | POSSIBLE CAUSE | SOLUTION | REF. |
|---|---|--|-------|
| Even holding down [RX→CS], the received call sign will not set to the destination call sign. | The call sign has not been correctly received. | Try it again, after the transceiver has correctly received the call sign. | — |
| | When a received signal is weak, or a signal is received during scanning, the call sign may not be received correctly. In that case, “----” is displayed and error beeps sound, and a reply call cannot be made. | | |
| A Local area call can be made, but the Gateway call or destination station call cannot be made. | MY call sign has not been registered on a D-STAR repeater. | Register your own call sign (MY) on a gateway repeater, or confirm the registration of the call sign. | p. 47 |
| | The repeater set in “FROM” (Access Repeater) has no Gateway. | Check the repeater settings. | — |
| “L” is displayed on the LCD. | While receiving through the internet, some packets may be lost due to network error (poor data throughput performance). | Wait a while, and try it again. ① When the transceiver receives corrupted data, and misidentifies it as packet loss, “L” is displayed, even if it is a Local area call. | — |
| “DV” and “FM” icons alternately blink. | While in the DV mode, an FM signal is received. | Use a different operating frequency until there are no FM signals on the original frequency. ① See the Automatic DV detection on the Advanced manual. | AM |

■ Updating the repeater list

For easy operation, a repeater list is preloaded into your transceiver. You can download the repeater list from the Icom website.

NOTE:

- Before using a microSD card, see page 25 for details of a card.
- See “Updating the repeater list” that can be downloaded from the Icom website about how to update the repeater list using a microSD card.

<https://www.icomjapan.com/support/>

INDEX

1 MHz tuning 16

A

A band 11
Accessories ii
Access Point mode v
Access repeater 51
AM 15
AM-N 15
Attenuator (ATT) 4, 16
Audio level 7
Auto Power OFF icon 4, 22

B

Band Scope 20
Band Select 15
Battery icon 6
Battery pack
 Attaching 5
 Charging 6
B band 11
BK 4
Bluetooth
 Connecting 32
 Deleting 33
 Disconnecting 33
 icon 3
 Pairing 32
 Turning ON 31

C

Call
 Gateway 44, 57
 Individual station 58
 Local 44, 56
 Simplex 18, 19, 44, 49
Call Channel mode 14
CALL key 2
Call sign 45
Call Sign Capture key 55
CD key 1
Character
 How to enter 46
Charging 6
CLR key 2

D

DC IN jack 2
Default setting 22
DIAL 2
DOC ii
DR function 14, 43
DR key 2
D-STAR 40
Dual band display 3, 11
DUAL key 1, 11
Dualwatch 11
DV 15
DV Gateway function v

E

Echo Test 62
EMR 4

F

FCC ii
FM 15
FM-N 15
FM Radio 20
FROM 63

G

Gateway call 44, 57
GPS 10, 29
 GPS Alarm icon 3
 GPS Logger function 30
 GPS POSITION screen 29
 GPS receiver iv

H

Home Channel function 18

L

L 4
Link to Reflector 60
Local call 44, 56
Lock function 20
LO key 2

M

MAIN band 11
MAIN key 1, 11
Memory channel
 Entering 23
 Selecting 24
Memory mode 14
Memory Scope 20
MEMORY screen 24

| | | |
|---------------------------------------|------------|--|
| MENU | | |
| List | 71 | |
| MENU key | 1 | |
| MENU screen | 21 | |
| Operation..... | 21 | |
| Selecting a item..... | 22 | |
| microSD card | | |
| Formatting | 8 | |
| Inserting..... | 7 | |
| Removing | 28 | |
| MIC/SP jack..... | 2 | |
| MODE key | 1 | |
| Monitor function..... | 12 | |
| MR key | 2 | |
| MW key..... | 2, 23 | |
| My Call Sign | 45 | |
| N | | |
| Near Repeater search function..... | vi, 63 | |
| O | | |
| Operating mode..... | 15 | |
| P | | |
| Pairing/Connect..... | 32 | |
| Partial Reset | 37 | |
| Playing a recorded audio..... | 27 | |
| PTT switch..... | 1 | |
| Q | | |
| QUICK key..... | 2 | |
| Quick Menu window | 13 | |
| R | | |
| Radio | 20 | |
| Receiving..... | 11 | |
| Receiving, DR | 53 | |
| Recording a QSO audio | 27 | |
| Reflector | 59 | |
| Echo Testing..... | 62 | |
| Linking | 60 | |
| Requesting repeater information | 62 | |
| Unlinking..... | 59 | |
| Using | 61 | |
| Repeater Information..... | 62 | |
| Repeater list | 66 | |
| Resetting | 37 | |
| RPT? | 65 | |
| RX..... | 65 | |
| RX→CS key | 2, 55 | |
| RX history | 53 | |
| S | | |
| Save Setting | 9 | |
| SCAN key..... | 1 | |
| Scan operation | 17 | |
| Screen Capture | 1 | |
| SD card | | |
| Formatting | 8 | |
| Inserting..... | 7 | |
| Removing | 28 | |
| Share Pictures function | vi, 3 | |
| Simplex..... | 18, 19, 49 | |
| Simplex call | 44 | |
| Single band display | 3, 11 | |
| SPCH key..... | 2 | |
| Specifications | 34 | |
| Speech function..... | 17 | |
| SQL key..... | 1 | |
| Squelch..... | 12 | |
| S/R/F meter | 4 | |
| T | | |
| Terminal mode | v | |
| TO..... | 64 | |
| Transmit power level | 19 | |
| Transmitting..... | 18, 19 | |
| Troubleshooting..... | 38 | |
| Troubleshooting, DR..... | 65 | |
| Tuning step | 16 | |
| Turning ON | 7 | |
| U | | |
| Unlink Reflector | 59 | |
| UR? | 52, 65 | |
| USB COM..... | 3 | |
| USB port | 2 | |
| Use Reflector..... | 61 | |
| V | | |
| VFO/MHz key | 2 | |
| VFO mode | 14 | |
| VOL | 2 | |
| VOX..... | 3 | |
| W | | |
| Waterfall function..... | vi | |
| Weather Channel mode..... | 14 | |

ABOUT THE LICENSES

Information on the open source software being used by this product.

COPYRIGHT NOTICE, DISCLAIMER, and LICENSE:

If you modify libpng you may insert additional notices immediately following this sentence.

This code is released under the libpng license.

libpng versions 1.2.6, August 15, 2004, through 1.6.12, June 12, 2014, are Copyright (c) 2004, 2006-2014 Glenn Randers-Pehrson, and are distributed according to the same disclaimer and license as libpng-1.2.5 with the following individual added to the list of Contributing Authors:

Cosmin Truta

libpng versions 1.0.7, July 1, 2000, through 1.2.5, October 3, 2002, are Copyright (c) 2000-2002 Glenn Randers-Pehrson, and are distributed according to the same disclaimer and license as libpng-1.0.6 with the following individuals added to the list of Contributing Authors:

Simon-Pierre Cadieux

Eric S. Raymond

Gilles Vollant

and with the following additions to the disclaimer:

There is no warranty against interference with your enjoyment of the library or against infringement. There is no warranty that our efforts or the library will fulfill any of your particular purposes or needs. This library is provided with all faults, and the entire risk of satisfactory quality, performance, accuracy, and effort is with the user.

libpng versions 0.97, January 1998, through 1.0.6, March 20, 2000, are Copyright (c) 1998, 1999, 2000 Glenn Randers-Pehrson, and are distributed according to the same disclaimer and license as libpng-0.96, with the following individuals added to the list of Contributing Authors:

Tom Lane

Glenn Randers-Pehrson

Willem van Schaik

libpng versions 0.89, June 1996, through 0.96, May 1997, are Copyright (c) 1996, 1997 Andreas Dilger Distributed according to the same disclaimer and license as libpng-0.88, with the following individuals added to the list of Contributing Authors:

John Bowler

Kevin Bracey

Sam Bushell

Magnus Holmgren

Greg Roelofs

Tom Tanner

libpng versions 0.5, May 1995, through 0.88, January 1996, are Copyright (c) 1995, 1996 Guy Eric Schlnat, Group 42, Inc.

For the purposes of this copyright and license, "Contributing Authors" is defined as the following set of individuals:

Andreas Dilger

Dave Martindale

Guy Eric Schlnat

Paul Schmidt

Tim Wegner

The PNG Reference Library is supplied "AS IS".

The Contributing Authors and Group 42, Inc. disclaim all warranties, expressed or implied, including, without limitation, the warranties of merchantability and of fitness for any purpose. The Contributing Authors and Group 42, Inc. assume no liability for direct, indirect, incidental, special, exemplary, or consequential damages, which may result from the use of the PNG Reference Library, even if advised of the possibility of such damage. Permission is hereby granted to use, copy, modify, and distribute this source code, or portions hereof, for any purpose, without fee, subject to the following restrictions:

1. The origin of this source code must not be misrepresented.
2. Altered versions must be plainly marked as such and must not be misrepresented as being the original source.
3. This Copyright notice may not be removed or altered from any source or altered source distribution.

The Contributing Authors and Group 42, Inc. specifically permit, without fee, and encourage the use of this source code as a component to supporting the PNG file format in commercial products. If you use this source code in a product, acknowledgment is not required but would be appreciated.

A "png_get_copyright" function is available, for convenient use in "about" boxes and the like:

```
printf("%s", png_get_copyright(NULL));
```

Also, the PNG logo (in PNG format, of course) is supplied in the files "pngbar.png" and "pngbar.jpg (88x31) and "pngnow.png" (98x31).

Libpng is OSI Certified Open Source Software. OSI Certified is a certification mark of the Open Source Initiative.

The contributing authors would like to thank all those who helped with testing, bug fixes, and patience.

This wouldn't have been possible without all of you.

Thanks to Frank J. T. Wojcik for helping with the documentation.

ZLIB DATA COMPRESSION LIBRARY

zlib 1.2.8 is a general purpose data compression library. All the code is thread safe. The data format used by the zlib library is described by RFCs (Request for Comments) 1950 to 1952 in the files <http://tools.ietf.org/html/rfc1950> (zlib format), [rfc1951](http://tools.ietf.org/html/rfc1951) (deflate format) and [rfc1952](http://tools.ietf.org/html/rfc1952) (gzip format).

All functions of the compression library are documented in the file `zlib.h` (volunteer to write man pages welcome, contact zlib@gzip.org). A usage example of the library is given in the file `test/example.c` which also tests that the library is working correctly. Another example is given in the file `test/minizip.c`. The compression library itself is composed of all source files in the root directory.

To compile all files and run the test program, follow the instructions given at the top of `Makefile.in`. In short `./configure`; `make test`, and if that goes well, "make install" should work for most flavors of Unix. For Windows, use one of the special makefiles in `win32/` or `contrib/vstudio/`. For VMS, use `make_vms.com`. Questions about zlib should be sent to zlib@gzip.org, or to Gilles Vollant info@winimage.com for the Windows DLL version. The zlib home page is <http://zlib.net/>. Before reporting a problem, please check this site to verify that you have the latest version of zlib; otherwise get the latest version and check whether the problem still exists or not. PLEASE read the zlib FAQ http://zlib.net/zlib_faq.html before asking for help.

Mark Nelson markn@ieee.org wrote an article about zlib for the Jan. 1997 issue of Dr. Dobbs' Journal; a copy of the article is available at <http://marknelson.us/1997/01/01/zlib-engine/>.

The changes made in version 1.2.8 are documented in the file `ChangeLog`.

Unsupported third party contributions are provided in directory `contrib/`.

zlib is available in Java using the `java.util.zip` package, documented at <http://java.sun.com/developer/technicalArticles/Programming/compression/>.

A Perl interface to zlib written by Paul Marquess pmqs@cpan.org is available at CPAN (Comprehensive Perl Archive Network) sites, including <http://search.cpan.org/~pmqs/IO-Compress-Zlib/>.

A Python interface to zlib written by A.M.Kuchling amk@amk.ca is available in Python 1.5 and later versions, see <http://docs.python.org/library/zlib.html>. zlib is built into tcl: <http://wiki.tcl.tk/4610>.

An experimental package to read and write files in .zip format, written on top of zlib by Gilles Vollant info@winimage.com, is available in the `contrib/minizip` directory of zlib.

Notes for some targets:

- For Windows DLL versions, please see `win32/DLL_FAQ.txt`

- For 64-bit Irix, `deflate.c` must be compiled without any optimization. With `-O`, one `libpng` test fails. The test works in 32 bit mode (with the `-n32` compiler flag). The compiler bug has been reported to SGI.
- zlib doesn't work with `gcc 2.6.3` on a DEC 3000/300LX under OSF/1 2.1 it works when compiled with `cc`.
- On Digital Unix 4.0D (formerly OSF/1) on AlphaServer, the `cc` option `-std1` is necessary to get `gzprintf` working correctly. This is done by `configure`.
- zlib doesn't work on HP-UX 9.05 with some versions of `/bin/cc`. It works with other compilers. Use "make test" to check your compiler.
- `gzdopen` is not supported on RISCOS or BEOS.
- For PalmOs, see <http://palmzlib.sourceforge.net/>

Acknowledgments:

The deflate format used by zlib was defined by Phil Katz. The deflate and zlib specifications were written by L. Peter Deutsch. Thanks to all the people who reported problems and suggested various improvements in zlib; they are too numerous to cite here.

Copyright notice:

(C) 1995-2013 Jean-loup Gailly and Mark Adler
This software is provided 'as-is', without any express or implied warranty. In no event will the authors be held liable for any damages arising from the use of this software.

Permission is granted to anyone to use this software for any purpose, including commercial applications, and to alter it and redistribute it freely, subject to the following restrictions:

1. The origin of this software must not be misrepresented; you must not claim that you wrote the original software. If you use this software in a product, an acknowledgment in the product documentation would be appreciated but is not required.
2. Altered source versions must be plainly marked as such, and must not be misrepresented as being the original software.
3. This notice may not be removed or altered from any source distribution.

Jean-loup Gailly Mark Adler

jloup@gzip.org madler@alumni.caltech.edu

If you use the zlib library in a product, we would appreciate *not* receiving lengthy legal documents to sign. The sources are provided for free but without warranty of any kind. The library has been entirely written by Jean-loup Gailly and Mark Adler; it does not include third-party code.

If you redistribute modified sources, we would appreciate that you include in the file `ChangeLog` history information documenting your changes. Please read the FAQ for more information on the distribution of modified source versions.

MENU SCREEN ITEMS

When pushing [MENU], the following MENU items are displayed.
Refer to the Advanced manual for each menu item's details.

| |
|-----------------------|
| VOICE |
| Record |
| TX Set |
| Repeat Time |
| TX Monitor |
| <<Single TX>> |
| <<Repeat TX>> |
| RECORD |
| QSO Recorder |
| <<REC Start>> |
| Play Files |
| Recorder Set |
| RX REC Condition |
| File Split |
| REC Operation |
| PTT Auto REC |
| Player Set |
| Skip Time |
| Voice Recorder |
| Record |
| Play Files |
| Recorder Set |
| MIC Gain |
| Player Set |
| Skip Time |
| DV Auto Reply |
| FM RADIO |
| FM Radio Memory |
| FM Radio Set |
| Auto Mute |
| Earphone Antenna |
| Power Save (FM Radio) |
| <<FM Radio ON>> |
| <<FM Radio Mode>> |

| |
|---------------------------|
| SCOPE |
| CD |
| DV GW |
| <<Terminal Mode>> |
| <<Access Point Mode>> |
| DV Gateway Connection |
| PICTURE |
| GPS |
| GPS Set |
| GPS Select |
| GPS Option |
| SBAS |
| GLONASS |
| Power Save |
| Satellite Information Out |
| Manual Position |
| GPS Out (USB Port) |
| GPS TX Mode |
| OFF |
| D-PRS |
| NMEA |
| GPS Information |
| GPS Position |
| GPS Memory |
| GPS Alarm |
| Alarm Select |
| Alarm Area (Group) |
| Alarm Area (RX/Memory) |
| GPS Logger |
| GPS Logger |
| Record Interval |
| Record Sentence |
| <<GPS Logger Only>> |
| GPS Auto TX |

MENU SCREEN ITEMS

| |
|-----------------------------|
| SET > DUP/TONE... |
| Offset Freq |
| Repeater Tone |
| TSQL Freq |
| Tone Burst |
| DTCS Code |
| DTCS Polarity |
| Digital Code |
| SET > Scan |
| Pause Timer |
| Resume Timer |
| Temporary Skip Timer |
| Program Skip |
| Group Link |
| P-Scan Edge |
| Program Link |
| DUP Check During MR Scan |
| SET > Scope |
| Scope Mode (VFO/CALL) |
| Displayed Steps |
| Waterfall Function |
| Waterfall Speed |
| FIX Mode Center Frequency |
| AF Output (DUAL/AIR Band) |
| SET > Call Sign |
| SET > My Station |
| My Call Sign |
| TX Message |
| My Call Sign (TM) |

| |
|-----------------------------|
| SET > DV Set |
| Tone Control |
| RX Bass |
| RX Treble |
| RX Bass Boost |
| TX Bass |
| TX Treble |
| Auto Reply |
| DV Data TX |
| DV Fast Data |
| Fast Data |
| GPS Data Speed |
| TX Delay (PTT) |
| Digital Monitor |
| Digital Repeater Set |
| DV Auto Detect |
| RX Record (RPT) |
| [RX>CS] Key |
| BK |
| EMR |
| EMR AF Level |
| SET > SPEECH |
| RX Call Sign SPEECH |
| RX>CS SPEECH |
| DIAL SPEECH |
| MODE SPEECH |
| SPEECH Language |
| Alphabet |
| SPEECH Speed |
| SPEECH Level |
| SET > DTMF/T-CALL |
| DTMF Memory |
| DTMF Speed |
| SET > QSO/RX Log |
| QSO Log |
| RX History Log |
| CSV Format |
| Separator/Decimal |
| Date |

MENU SCREEN ITEMS

| | |
|-------------------------------------|---|
| SET > Function | |
| Power Save | |
| Monitor | |
| Dial Speed-UP | |
| Auto Repeater*1 | |
| Remote MIC Key | |
| | During RX/Standby |
| | During TX |
| Key Lock | |
| PTT Lock | |
| Busy Lockout | |
| Time-Out Timer | |
| Active Band | |
| MIC Gain (Internal) | |
| MIC Gain (External) | |
| VOX | |
| | VOX |
| | VOX Level |
| | VOX Delay |
| | VOX Time-Out Timer |
| | Headset Select |
| CI-V | |
| | CI-V Address |
| | CI-V Baud Rate (SP Jack) |
| | CI-V Transceiver |
| | CI-V USB/Bluetooth→REMOTE Transceiver Address |
| USB Connect | |
| USB Serialport Function | |
| Heterodyne | |
| Battery Pack Select | |
| Battery Pack Confirmation | |
| Charging (Power ON) | |
| USB Power Input (Phone, Tablet, PC) | |
| Screen Capture [PWR] Key | |
| Screen Capture File Type | |
| LO/CALL Key Actions | |

| | |
|---------------------------|--------------------|
| SET > Display | |
| Backlight | |
| Backlight Timer | |
| Brightness | |
| Dim Screen | |
| Dim Timer | |
| Brightness (Dim) | |
| Screen Saver | |
| Background Color | |
| Contrast | |
| Busy LED | |
| RX Call Sign | |
| RX Position Indicator | |
| RX Position Display | |
| RX Position Display Timer | |
| Reply Position Display | |
| RX Picture Indicator | |
| DV RX Backlight | |
| TX Call Sign | |
| Scroll Speed | |
| Opening Message | |
| Voltage (Power ON) | |
| Single Band Display | |
| Display Unit | |
| | Latitude/Longitude |
| | Altitude/Distance |
| | Speed |
| | Temperature |
| | Barometric |
| | Rainfall |
| | Wind Speed |
| Display Language*2 | |
| System Language | |

*1 May be displayed depending on the transceiver version.

*2 Displayed only when "System Language" is set to "Japanese."

MENU SCREEN ITEMS

| |
|--------------------------|
| SET > Sounds |
| Volume Select |
| FM Radio Level |
| Earphone Mode |
| Beep Level |
| Beep/Vol Level Link |
| Key-Touch Beep |
| Home CH Beep |
| Band Edge Beep |
| Scan Stop Beep |
| Standby Beep |
| Sub Band Mute |
| SET > Time Set |
| Date/Time |
| GPS Time Correct |
| UTC Offset |
| Auto Power OFF |
| SET > SD Card |
| Load Setting |
| Save Setting |
| Save Form |
| Import/Export |
| Import |
| Export |
| CSV Format |
| Opening Picture |
| SD Card Info |
| Screen Capture View |
| TX/RX Picture View |
| Firmware Update |
| Format |
| Unmount |

| |
|-------------------------------|
| SET > Bluetooth Set |
| Bluetooth |
| Auto Connect |
| Pairing/Connect |
| Device Search |
| Pairing List* ³ |
| <<Pairing Reception>> |
| Headset Set |
| AF Output |
| Headset Function Select |
| Auto Disconnect |
| VOX |
| Icom Headset |
| Data Device Set |
| Serialport Function |
| Bluetooth Device Information |
| Initialize Bluetooth Device |
| SET > Others |
| Information |
| Voltage |
| Version |
| Clone |
| Clone Mode |
| Reset |
| Partial Reset |
| All Reset |
| MEMORY |
| Memory CH |
| Call CH |
| Your Call Sign |
| Repeater List |

*³ Paired devices are displayed.

