

ICOM

BIIS 1200
Compatible

INSTRUCTION MANUAL

VHF TRANSCEIVER

IC-F51

UHF TRANSCEIVER

IC-F61



II 2G Ex ib II A T3 Gb

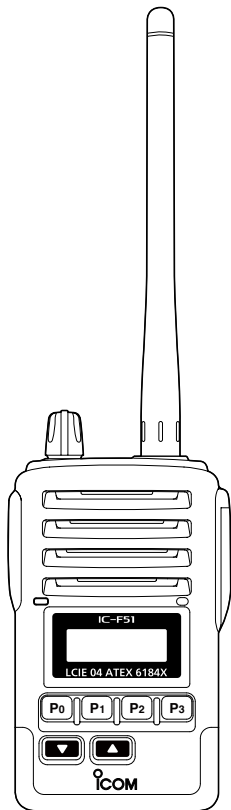

This illustration shows the IC-F51.

icom Inc.

IMPORTANT

READ ALL INSTRUCTIONS carefully and completely before using the transceiver.



SAVE THIS INSTRUCTION MANUAL— This instruction manual contains important operating instructions for the IC-F51 VHF TRANSCEIVER and IC-F61 UHF TRANSCEIVER.

 This instruction manual includes some functions which are usable only when they are pre-programmed by your dealer. Ask your dealer for details.

OPERATING NOTES

- When transmitting with a portable transceiver, hold the transceiver in a vertical position with its microphone 5 to 10 centimeters away from your mouth. Keep the antenna at least 2.5 centimeters from your head and body.
- If you wear a portable transceiver on your body, ensure that the antenna is at least 2.5 centimeters from your body when transmitting.

EXPLICIT DEFINITIONS

WORD	DEFINITION
 DANGER!	Personal death, serious injury or an explosion may occur.
 WARNING!	Personal injury, fire hazard or electric shock may occur.
CAUTION	Equipment damage may occur.
NOTE	If disregarded, inconvenience only. No risk of personal injury, fire or electric shock.

RECOMMENDATION

CLEAN THE TRANSCEIVER THOROUGHLY IN A BOWL OF FRESH WATER after exposure to saltwater, and dry it before operating. Otherwise, the transceiver's keys, switches and controllers may become unusable, due to salt crystallization, and/or the charging terminals of the battery pack may corrode.

 **NOTE:** If the transceiver's waterproof protection appears defective, carefully clean it with a soft, damp (fresh water) cloth, then, dry it before operating. The transceiver may lose its waterproof protection if the case, jack cover is cracked or broken, or the transceiver has been dropped.
Contact your Icom distributor or your dealer for advice.

Icom is not responsible for the destruction, damage to, or performance of any Icom or non-Icom equipment, if the malfunction is because of:

- Force majeure, including, but not limited to, fires, earthquakes, storms, floods, lightnings, or other natural disasters, disturbances, riots, war, or radioactive contamination.
- The use of Icom transceiver with any equipment that is not manufactured or approved by Icom.

INTRINSIC SAFETY



Versions of the IC-F51/F61 which display the “EX” marking on the serial number seal.

The approval rating for these models is II 2G Ex ib IIA T3 Gb.

WARNING! NEVER charge the BP-227AX (with/without the transceiver) in an explosive atmosphere. The optional battery chargers are not approved as Intrinsically Safe.

When the transceiver is used in a hazardous area, the BP-227AX **MUST** be attached, either the jack cover or HM-138 **MUST** be attached to the speaker-microphone connector.

KEEP the transceiver and the BP-227AX clean to avoid any risk of ignition due to the build-up of electrostatic charges.

Repair of Icom transceivers should only be carried out by authorized Icom distributors. In particular, repair of ATEX approved transceivers can **ONLY** be done by Icom to maintain the intrinsically safe rating. **NEVER** attempt to repair an ATEX approved transceivers. Only Icom has the repair expertise and procedures to maintain the ATEX approval. Contact your Icom distributor or authorised dealer for details.

The equipment can be used without the microphone but with the jack cover.

The ATEX standard is described on the sticker (Ex Marking) and BP-227AX as below.

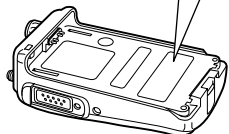

* The following illustrations show the IC-F51/F61.

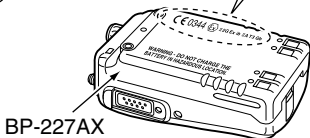
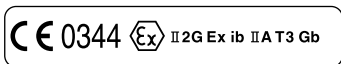

BP-227AX

- DO NOT OPEN WHEN AN EXPLOSIVE ATMOSPHERE MAY BE PRESENT.
- DO NOT CHARGE THE BATTERY IN HAZARDOUS LOCATION.

PRECAUTIONS

⚠ **DANGER! NEVER** short the terminals of the battery pack. Shorting may occur if the terminals touch metal objects such as a key, so be careful when placing the battery packs (or the transceiver) in bags, and so on. Carry them so that shorting cannot occur with metal objects. Shorting may damage not only the battery pack, but also the transceiver.

⚠ **DANGER! NEVER** use and charge Icom battery packs with non-Icom transceivers or non-Icom chargers. Only Icom battery packs are tested and approved for use with Icom transceivers or charged with Icom chargers. Using third-party or counterfeit battery packs or chargers may cause smoke, fire, or cause the battery to burst.

⚠ **WARNING! NEVER** hold the transceiver so that the antenna is very close to, or touching exposed parts of the body, especially the face or eyes, while transmitting.

⚠ **WARNING! NEVER** operate the transceiver with earphone, headphones or other audio accessories at high volume levels. The continuous high volume operation may cause a ringing in your ears. If you experience the ringing, reduce the volume level or discontinue use.

⚠ **WARNING! NEVER** operate the transceiver while driving a vehicle. Safe driving requires your full attention—anything less may result in an accident.

CAUTION: DO NOT connect the transceiver to a power source other than the BP-227AX. Such a connection will ruin the transceiver.

CAUTION: DO NOT operate the transceiver unless the flexible antenna, battery pack and jack cover are securely attached. Confirm that the antenna and battery pack are dry before attaching. Exposing the inside of the transceiver to dust or water can cause serious damage to the transceiver.

CAUTION: DO NOT place or leave the transceiver in direct sunlight or in places with temperatures below -20°C or above $+55^{\circ}\text{C}$.

CAUTION: DO NOT modify the transceiver. The specifications may change and then the transceiver may not comply with the requirements of required regulations. The transceiver warranty does not cover any problems caused by unauthorized modification.

CAUTION: DO NOT use harsh solvents such as Benzine or alcohol when cleaning, because they will damage the transceiver surfaces.

DO NOT push [PTT] when you do not actually intend to transmit.

BE CAREFUL! The transceiver will become hot when operating it continuously for long periods of time.

BE CAREFUL! The transceiver meets IP67* requirements for dust-tight and waterproof protection. However, once the transceiver has been dropped, dust-tight and waterproof protection cannot be guaranteed because of possible damage to the transceiver's case or the waterproof seal.

* Only when the battery pack and jack cover are attached.

MAKE SURE to turn OFF the transceiver power before connecting or disconnecting the supplied or optional accessory.

Even when the transceiver power is OFF, a slight current still flows in the circuits. Remove the battery pack or batteries from the transceiver when not using it for a long time. Otherwise, the installed battery pack or batteries will become exhausted, and will need to be recharged or replaced.

TABLE OF CONTENTS

IMPORTANT	i
OPERATING NOTES.....	i
EXPLICIT DEFINITIONS.....	i
RECOMMENDATION	ii
INTRINSIC SAFETY.....	iii
PRECAUTIONS.....	v
SUPPLIED ACCESSORIES.....	viii
1 ACCESSORIES	1
■ Accessory attachments	1
2 PANEL DESCRIPTION.....	3
■ Front, top and side panels	3
■ Function display.....	6
■ Programmable function keys	7
3 CONVENTIONAL OPERATION.....	12
■ Turning power ON.....	12
■ Channel selection	12
■ Call procedure	13
■ Receiving and transmitting	14
■ Scrambler function.....	17
■ User Set mode.....	18
4 BIIS OPERATION	19
■ Default setting.....	19
■ Receiving a call.....	20
■ Transmitting a call	23
■ Receiving a message	26
■ Transmitting a status	29
■ Transmitting an SDM.....	30
■ Position data transmission.....	31
■ Printer connection.....	32
■ PC connection	32
■ Digital ANI.....	32

■ Auto emergency transmission	33
■ Stun function.....	33
■ BUIS indication.....	34
■ Priority A channel selection	34
5 BATTERY CHARGING	35
■ Caution	35
■ Optional battery chargers	39
6 SPEAKER-MICROPHONE	45
■ Optional HM-138 description	45
■ Attachment.....	46
7 OPTIONS	47
8 ATEX CAUTIONS.....	49
9 INFORMATION	53
■ About CE and DOC	53
■ Disposal.....	53

SUPPLIED ACCESSORIES

The following accessories are supplied:	Qty.
• Flexible antenna.....	1
• Battery pack	1
• Jack cover	1 set
• Belt clip	1 set
• Function name stickers* (KEY-STICKER).....	1

*There are no names on the programmable function keys since the functions can be freely assigned to [P0] to [P3], [Red], [▼] and [▲] keys. Attach the supplied function name stickers above the appropriate keys for easy recognition of that key's assigned function.

1 ACCESSORIES

■ Accessory attachments

◇ Flexible antenna

Connect the supplied flexible antenna to the antenna connector.

CAUTION:

- **NEVER** carry the transceiver by holding the antenna.
- **DO NOT** connect the antenna other than listed on page 47.
- Transmitting without an antenna may damage the transceiver.

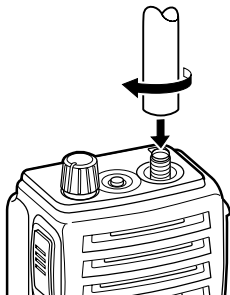

◇ Jack cover

Attach the jack cover when the optional speaker-microphone is not used.

When the transceiver is used in a hazardous areas, either the jack cover or HM-138 must be attached to the connector. Failure to do this will make the transceiver ATEX non-compliant and may result in an accident during use in hazardous areas.

To attach the jack cover:

- 1 Insert the jack cover into the [SP MIC] connector.
- 2 Tighten the screw.

To detach the jack cover:

- 1 Remove the screw with a phillips screwdriver.
- 2 Detach the jack cover for the speaker-microphone connection.

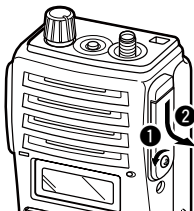
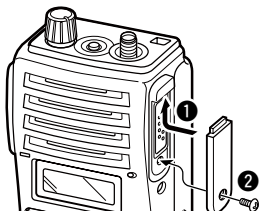

◇ Battery pack

To attach the battery pack:

Slide the battery pack on the back of the transceiver in the direction of the arrow (1), then lock it with the battery release button.

- Slide the battery pack until the battery release button makes a 'click' sound.

To remove the battery pack:

Push the battery release button in the direction of the arrow (2) as shown below. The battery pack is then removed.

NOTE: Keep the battery terminals clean. It's a good idea to occasionally clean them.

NEVER remove or attach the battery pack when the transceiver is wet or soiled. This may result in water or dust getting into the transceiver/battery pack and may damage the transceiver.

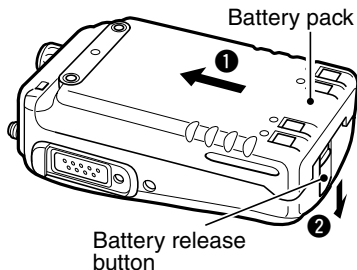

◇ Belt clip

Attach the belt clip to the back of the transceiver with the supplied screws.

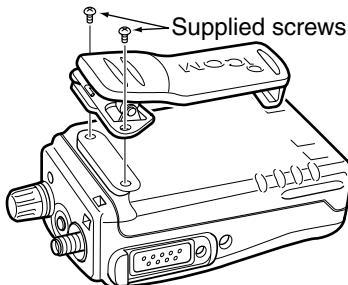

2 PANEL DESCRIPTION

■ Front, top and side panels

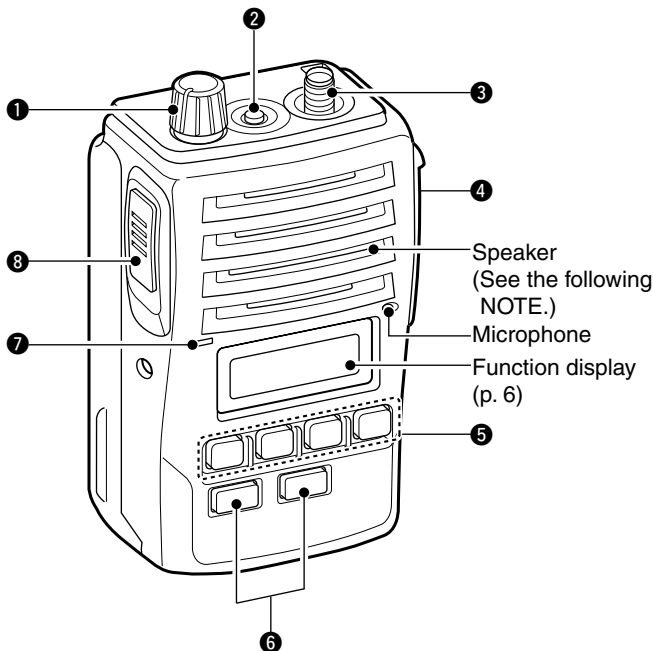

NOTE: If the speaker netting (for dust proofing) becomes wet, dry it with a hair drier (cool mode) etc. before operating the transceiver. Otherwise the audio may be difficult to hear for loss of the sound pressure.

1 VOLUME CONTROL [VOL]

Turns ON the transceiver and adjusts the audio level.

2 RED BUTTON

A desired function can be assigned by your dealer.

3 ANTENNA CONNECTOR

Connects to the supplied antenna.

4 SPEAKER-MICROPHONE CONNECTOR [SP MIC]

Connects to the optional speaker-microphone. (p. 46)

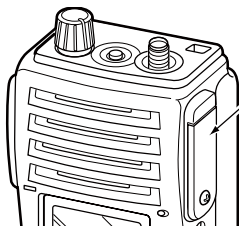

[SP MIC] jack cover

NOTE: KEEP the [SP MIC] jack cover attached to the transceiver when the speaker-microphone is not used. (See page 1 for details)

5 DEALER-PROGRAMMABLE KEYS [P0] to [P3]

Desired functions can be independently assigned by your dealer.

6 CH UP AND DOWN KEYS [▼]/[▲]*

- During standby, push to select an operating channel.
- After pushing [TX Code CH Select], push to select a TX code channel.
- After pushing [DTMF Autodial], push to select a DTMF channel.
- After holding down [Scan A Start/Stop]/[Scan B Start/Stop], push to select a scan group.
- After pushing [Digital], push to select a BIIS code, status number or SDM.

*Desired functions can be independently assigned by your dealer.

➤ Continue on the next page.

2 PANEL DESCRIPTION

■ Front, top and side panels (Continued)

⑦ TRANSMIT/BUSY INDICATOR

Lights red while transmitting, lights green while receiving a signal, or when the squelch is open.

⑧ PTT SWITCH [PTT]

Hold down to transmit, release to receive.

■ Function display

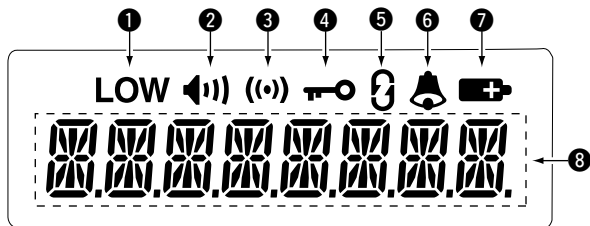

① OUTPUT POWER INDICATOR

Displayed when Low 2 or Low 1 is selected.

② AUDIBLE INDICATOR

- Displayed when the channel is in the 'audible' (unmute) mode.
- Displayed when the specified 5-tone/BIIS code is received.

③ COMPANDER INDICATOR

Displayed when the compander function is activated.

④ KEY LOCK INDICATOR

Displayed while the key lock function is ON.

⑤ SCRAMBLER INDICATOR

Displayed when the voice scrambler function is ON.

⑥ BELL INDICATOR

Displayed or blinks when the specific 5-tone/BIIS code is received, depending on the presetting.

⑦ BATTERY INDICATOR

Displayed or blinks when the battery power decreases to a specified level.

⑧ ALPHANUMERIC DISPLAY

Displays the operating channel number, channel names, Set mode contents, DTMF numbers, and so on.

■ Programmable function keys

The following functions can be assigned to [P0], [P1], [P2], [P3], [Red], [▼] and [▲] programmable function keys.

Consult your Icom dealer or system operator for details concerning your transceivers presetting.

CH UP AND DOWN KEYS

- Select an operating channel.
- Select a transmit code channel after pushing the [TX Code CH Select] keys.
- Select a DTMF channel after pushing the [DTMF Autodial] key.
- Select a scan group after holding down the [Scan A Start/Stop]/[Scan B Start/Stop] keys.
- Select a BIIS code, status number or SDM after pushing the [Digital] key.

BANK SELECT KEY

Push this key, then push [CH Up] or [CH Down] to select the desired bank.

SCAN START/STOP KEYS

- Push to start scanning. Push again to stop the scan.
- Hold down for 1 second to open the scan group, then select the desired scan group using [CH Up]/[CH Down].

SCAN TAG KEY

Push to add or delete the selected channel to the scan group.

PRIORITY CHANNEL KEYS

- Push to select Priority A or Priority B channels.
- Hold down [Prio A (Rewrite)] or [Prio B (Rewrite)] for 1 second to rewrite the Priority A or B channel.

MR-CH 1/2/3/4 KEYS

Directly select an operating channel.

MONITOR KEY

Independently a one or two of the following functions on each channel:

- While holding down, audio is heard ('Audible' mode).
- Push to mute the channel ('Inaudible' mode).
- Push to unmute the channel ('Audible' mode).
- After the communication is finished, push to send a 'reset code.'

 **NOTE:** The 'Audible' (unmute) mode may automatically return to the 'Inaudible' (mute) mode after a specified period.

LOCK KEY

Hold down for 1 second to electronically lock all assigned keys except the [Call] (incl. Call A and Call B), [Moni(Audi)] and [Emergency] keys.

OUTPUT POWER SELECTION KEY

Select the transmit output power temporarily or permanently, depending on the presetting.

- Ask your dealer for the output power level for each selection.

2 PANEL DESCRIPTION

C.TONE CHANNEL ENTER KEY

Select the continuous tone channel using [CH Up]/[CH Down] keys to change the tone frequency/code setting after pushing this key.

TALK AROUND KEY

Push to turn the talk around function ON or OFF.

- The talk around function equalizes the transmit frequency to the receive frequency for transceiver-to-transceiver communication.

WIDE/NARROW KEY

Push to toggle the IF bandwidth between wide and narrow.

- The wide passband width can be set to 25.0 or 20.0 kHz using the CS-F50 CLONING SOFTWARE. Ask your dealer for details.

DTMF AUTODIAL KEY

- Push to enter the DTMF channel selection mode. Then select the desired DTMF channel using the [CH Up]/[CH Down] keys.
- After selecting the desired DTMF channel, push to transmit the DTMF code.

DTMF RE-DIAL KEY

Push to transmit the last-transmitted DTMF code.

CALL KEYS

Push to transmit a 5-tone/BIIS ID code.

- Call transmission is necessary before you call another station depending on your signalling system.
- The [Call A] and/or [Call B] keys may be available when your system employs selective 'Individual/Group' calls. Ask your dealer which call is assigned to each key.

EMERGENCY KEYS

- Hold down for preset period of time to transmit an emergency call.
- When [Emergency Single (Silent)] or [Emergency Repeat (Silent)] is pushed, an emergency call is transmitted without a beep sound or LCD indication change.
 - If you want to cancel the emergency call, push (or hold down) the key again before transmitting the call.
 - The emergency call is transmitted only once or repeatedly until receiving a control code, depending on the presetting.

TX CODE ENTER KEY

Push to enter the direct ID code edit mode, for both the 5-tone and MSK. Then set the desired digit using [CH Up]/[CH Down] or [TX Code CH Up]/[TX Code CH Down]. (p. 16)

TX CODE CHANNEL SELECT KEY

- Push to enter the direct ID code channel selection mode. Then set the desired channel using [CH Up]/[CH Down] or [TX Code CH Up]/[TX Code CH Down]. (p. 15)
- While in the ID code channel selection mode, push for 1 second to enter the ID code edit mode. Then set the desired digit using [CH Up]/[CH Down] or [TX Code CH Up]/[TX Code CH Down]. (p. 16)

TX CODE CHANNEL UP/DOWN KEYS

Push to directly select a TX code channel.

ID MEMORY READ KEY

- Recalls the detected ID codes.
 - Push this key, then push [CH Up]/[CH Down] to select.
 - Up to 5 ID's are memorized.
- Hold down for 1 second to erase the selected memorized ID's.

2 PANEL DESCRIPTION

VOICE SCRAMBLER FUNCTION

Push to toggle the voice scrambler function ON or OFF.

COMPANDER KEY

Push to toggle the compander function ON or OFF.

The compander function reduces noise components from the transmitting audio to provide clear communication.

USER SET MODE KEY

- Hold down for 1 second to enter the User Set mode.
 - During the User Set mode, push this key to select an item that is enabled by your dealer, and push [CH Up]/[CH Down] to change the value or condition.
- Hold down for 1 second this key again to exit the User Set mode.

DIGITAL KEY (BIIS operation only)

- Push to select the call ID list, transmit message and standby condition. Toggles between queue channel and received message record indication after queue channel is selected.
- Hold down for 1 second to select queue channel indication.

STATUS UP/DOWN KEYS (BIIS operation only)

- While in the standby condition, push to display the transmit status indication and select a status number.
- When a received SDM is displayed, push to cancel the automatic scroll and scroll the message manually.
- When an SDM that contains more than 8 characters is displayed, push to scroll the message manually.

■ Turning power ON

- ① Rotate [VOL] to turn power ON.
- ② If the transceiver is programmed for a start up passcode, input digit codes as directed by your dealer.
 - The keys in the table below can be used for password input:
 - The transceiver detects numbers in the same block as identical. Therefore “01234” and “56789” are the same.

KEY	P0	P1	P2	P3	▼ / ▲
NUMBER	0	1	2	3	4
	5	6	7	8	9

- ③ When the “PASSWORD” indication does not clear after inputting 4 digits, the input code number may be incorrect. Turn the power off and start over in this case.

■ Channel selection

Several types of channel selections are available. Methods may differ according to your system set up.

NON-BANK TYPE:

Push [▼]/[▲] to select the desired operating channel, in sequence; or, push one of the [MR-CH 1] to [MR-CH 4] keys to select a channel directly.

BANK-TYPE:

Push [Bank], then push [▼] or [▲] to select the desired bank.

AUTOMATIC SCAN TYPE:

Channel setting is not necessary for this type. When turning the power ON, the transceiver automatically starts scanning. Scanning stops when receiving a call.

/// **NOTE:** If the Move to Priority A channel at Power ON function is turned ON, the transceiver does not start scanning at power ON. Consult your Icom dealer or system operator for details.

■ Call procedure

When your system employs tone signalling (excluding CTCSS and DTCSS), the call procedure may be necessary prior to voice transmission. The tone signalling employed may be a selective calling system which allows you to call specific station(s) only and prevent unwanted stations from contacting you.

- ① Select the desired TX code channel or 5-tone code according to your System Operator's instructions.
 - This may not be necessary depending on programming.
 - Refer to pages 15 and 16 for selection.
- ② Push [Call] (assigned to one of the dealer programmable keys).
- ③ After transmitting a 5-tone code, the remainder of your communication can be carried out in the normal fashion.

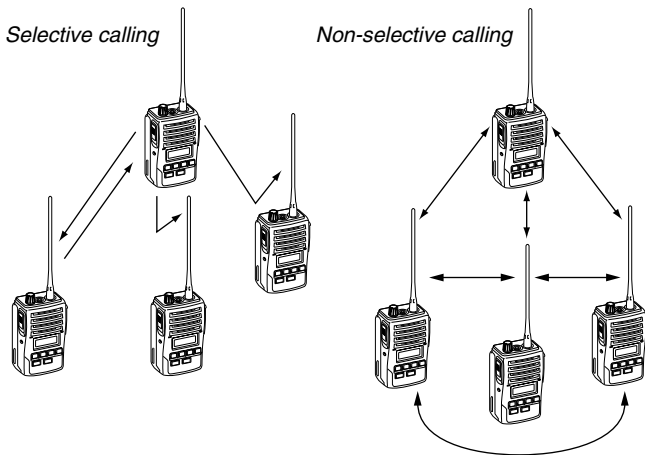

■ Receiving and transmitting

NOTE: Transmitting without an antenna may damage the transceiver. See page 1 for antenna attachment.

Receiving:

- ① Rotate [VOL] to turn power ON.
- ② Push [▼] or [▲] to select a channel.
- ③ When receiving a call, adjust the audio output level to a comfortable listening level.

Transmitting:

Wait for the channel to become clear to avoid interference.

- ① While holding down [PTT], speak into the microphone at a normal voice level.
 - When a tone signalling system is used, the call procedure as described to the left may be necessary.
- ② Release [PTT] to return to receive.

IMPORTANT: To maximize the readability of your signal.

1. Pause briefly after pushing [PTT].
2. Hold the microphone 5 to 10 cm from your mouth, then speak into the microphone at a normal voice level.

◇ Transmitting notes

• Transmit inhibit function

The transceiver has several inhibit functions which restrict transmission under the following conditions:

- The channel is in mute condition ('Inaudible' condition: "🔇") does not appear).
- Channel is busy.
- Un-matched (or matched) CTCSS is received.
- The selected channel is a 'receive only' channel.

• Time-out timer

After continuous transmission for the pre-programmed time period, the time-out timer is activated, causing the transceiver to stop transmitting.

• Penalty timer

Once the time-out timer is activated, transmission is further inhibited for a period determined by the penalty timer.

◇ TX code channel selection

If the transceiver has [TX Code CH Select] assigned to it, indication can be toggled between the operating channel number (or name) and TX code channel number (or name). When the TX code channel number (or name) is displayed, the [▼]/[▲] key selects the TX code channel.

TO SELECT A TX CHANNEL:

- ① Push [TX Code CH Select]— a TX code channel appears.
- ② Push [▼]/[▲] to select the desired TX code channel.
- ③ Push [Call] (or [PTT] during MSK operation) to transmit the selected TX code.
- ④ Push [TX Code CH Select] again to return to the operating channel number indication.

FOR TX CODE CHANNEL TYPE:

If the transceiver has a [TX Code CH Up] or [TX Code CH Down] key assignment, the programmed TX code channel can be selected directly.

◇ TX code number edit

If the transceiver has [TX Code CH Select] or [TX Code Enter] assigned to it, TX code contents can be edited within the allowable digits.

TO EDIT A TX CODE VIA [TX CODE CH SELECT] KEY:

- ① Push [TX Code CH Select] to enter the TX code channel selection mode.
 - Select the desired channel using [▼]/[▲] if necessary.
- ② Push [TX Code CH Select] for 1 second to enter the TX code edit mode.
- ③ Push [TX Code CH Select] to select the desired digit to be edited.
- ④ Set the desired digit using [▼]/[▲]/[TX Code CH Up]/[TX Code CH Down].
- ⑤ Push [TX Code CH Select] to set the digit. The editable digit will move to the right automatically.
- ⑥ Repeat ④ and ⑤ to input all allowable digits.
- ⑦ Push [Call] or [PTT] to transmit the selected TX code.

TO EDIT A TX CODE VIA [TX CODE ENTER] KEY:

- ① Select the desired TX code channel via [TX Code CH Up]/[TX Code CH Down].
- ② Push [TX Code Enter] to enter the TX code edit mode.
- ③ Push [TX Code Enter] to select the desired digit to be edited.
- ④ Set the desired digit using [▼]/[▲]/[TX Code CH Up]/[TX Code CH Down].
- ⑤ Push [TX Code Enter] to set the digit. The editable digit will move to the right automatically.
- ⑥ Repeat ④ and ⑤ to input all allowable digits.
- ⑦ Push [Call] or [PTT] to transmit the selected TX code.

3 CONVENTIONAL OPERATION

◇ DTMF transmission



If the transceiver has [DTMF Autodial] assigned to it, the automatic DTMF transmission function is available. Up to 8 DTMF channels are available.

TO SELECT A TX CODE:

- ① Push [DTMF Autodial]— a DTMF channel appears.
- ② Push [▼]/[▲] to select the desired DTMF channel.
- ③ Push [DTMF Autodial] to transmit the DTMF code in the selected DTMF channel.

■ Scrambler function

The voice scrambler function provides private communication between stations. The frequency inversion type is equipped to all versions, and some versions have the Rolling or Non-rolling type installed.

- ① Push [Scrambler] to turn the scrambler function ON.
 - “” appears.
- ② Push [Scrambler] again to turn the scrambler function OFF.
 - “” disappears.

■ User Set mode

If the transceiver has [User Set Mode] assigned to it, you can “customize” the transceiver operation to suit your preferences and operating style.

3

Entering the User Set mode:

- ① Hold down [User Set Mode] for 1 second to enter the User Set mode.
- ② Push [User Set Mode] momentarily to select the appropriate item.
Then push [CH Up] or [CH Down] to set the desired level/condition.

Available set mode functions:

- Backlight: ON, Auto or OFF
 - Beep: ON or OFF
 - SQL Level: 0 to 255
 - AF Min level: ON or OFF
 - Mic Gain: 1 to 5
 - Battery Voltage: ON or OFF
- ③ Hold down [User Set Mode] for 1 second again to exit the User Set mode.

4 BIIS OPERATION



■ Default setting

The following functions are assigned to each programmable key as the default. Ask your dealer for details.

- [P0]: Call : Push to transmit a 5-tone/BIIS call when the selected channel is a 5-tone or MSK channel, respectively.
- [P1]: Digital : Push to select the call list ID/transmit message, or to display the receive message record for selection.
- [P3]: Moni(Audi) : Push this key after the communication to send a "clear down" signal during MSK channel operation.
- [▼]/[▲]: CH Down/Up : While in the standby condition, selects the operating channel.
After pushing [Digital] or [TX Code CH Select], push to select the call list or TX code channel, respectively.
- [P2]/[Red]: Null : No function is assigned.

■ Receiving a call

◇ Individual call

- ① When an individual call is received:
 - Beeps sound.
 - “” is displayed and the mute is released.
 - The entered text message (Example: “CALLING”) and the calling station ID (or text) is alternately displayed, depending on the pre-setting.
 - “” is displayed or blinks, depending on the presetting.

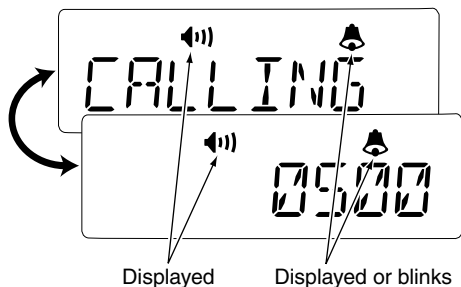



- ② Hold down [PTT], and then speak into the microphone at your normal voice level.
 - The transmit/busy indicator lights red.
- ③ Release [PTT] to return to receive.
 - The transmit/busy indicator lights green while receiving a signal.
- ④ To finish the conversation, push [P3] (Moni(Audi)) to send a “Clear down” signal.
 - Either station can send a clear down signal.
 - “CLR DOWN” is displayed for approximately 2 seconds.
 - “” disappears and the transceiver returns to the standby condition.

4 BIIS OPERATION

◇ Group call

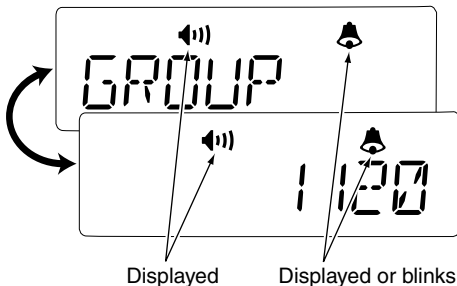
① When a group call is received:

- Beeps sound.
- “

The diagram shows two stages of a digital display. The top stage shows the word "GROUP" in large characters, with a mute icon (a speaker with a diagonal line through it) positioned above the word. The bottom stage shows the number "1120" in large characters, with a bell icon positioned above the number. A curved arrow on the left points from the top stage to the bottom stage, indicating a sequence. Two arrows point from the text below to the icons: one from "Displayed" to the mute icon, and one from "Displayed or blinks" to the bell icon.

② Hold down [PTT], and then speak into the microphone at your normal voice level.

⚡ **NOTE:** Only one station can transmit at a time.

- The transmit/busy indicator lights red.

③ Release [PTT] to return to receive.

- The transmit/busy indicator lights green while receiving a signal.

④ To finish the conversation, push [P3] (Moni(Audi)) to send the “Clear down” signal.

- Either station can send a clear down signal.
- “CLR DOWN” is displayed for approximately 2 seconds.
- “

21

◇ Displaying the received call record — Queue indication

The transceiver memorizes the calling station IDs for a call record. Up to 3 calls can be memorized, and the oldest call record is erased when the 4th call is received. However, once the transceiver is powered OFF, the all records are cleared.

- ① Hold down [P1] (Digital) for 1 second.
 - Displays following:

When a record is available



--QUEUE 1--

When no record is available



NO QUEUE

- ② Push [▼]/[▲] to select the desired call.
- ③ Hold down [P1] (Digital) for 1 second again to return to the standby condition.
 - When no operation is performed for 30 seconds, the transceiver automatically returns to the standby condition.

■ Transmitting a call

There are 3 ways to select a code—selecting the call code from memory, entering the call code from the keypad and calling back from the queue channel record.

◇ Using call memory

- ① While in the standby condition, push [P1] (Digital) to enter the call code memory channel selection mode.

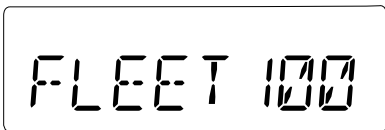

Call code text is displayed.

- ② Push [▼]/[▲] to select the desired call code.
- ③ Push [P0] (Call) or [PTT]* to call.
*PTT call can be made only when PTT call capability is permitted.

NOTE: When no answer back is received, the transceiver automatically repeats the call 3 times (default), and “WAIT” is displayed during each call. However, an error beep sounds and “FAILED” is displayed when no answer back is received after the calls.

- ④ Push [PTT] to transmit, release to receive.
- ⑤ Push [P3] (Moni(Audi)) to send the “Clear down” signal.

◇ Calling back from the queue channel

- ① While in the standby condition, hold down [P1] (Digital) for 1 second to enter queue memory channel selection mode.
- ② Push [▼]/[▲] to select the desired record.



--QUEUE 1--

- ③ Push [P0] (Call) or [PTT]* to call.

*PTT call can be made only when PTT call capability is permitted.

NOTE: When no answer back is received, the transceiver automatically repeats the call 3 times (default), and "WAIT" is displayed during each call. However, an error beep sounds and "FAILED" is displayed when no answer back is received after the calls.

- ④ Push [PTT] to transmit, release to receive.
- ⑤ Push [P3] (Moni(Audi)) to send the "Clear down" signal.

4 BIIS OPERATION

◇ Direct code entry

- ① While in the standby condition, push [TX Code Enter] to enter the TX code edit mode.
 - Editable code digit blinks.

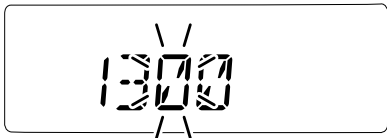

- ② Push [TX Code Enter] to select the desired digit to be edited.
 - Editable digit differs according to the setting.
- ③ Set the desired digit using [▼]/[▲]/[TX Code CH Up]/[TX Code CH Down].
- ④ Push [TX Code Enter] to set the digit. The editable digit will move to the right automatically.
- ⑤ Repeat ③ and ④ to input all allowable digits.
- ⑥ Push [P0] (Call) or [PTT]* to call.

*PTT call can be made only when PTT call capability is permitted.

NOTE: When no answer back is received, the transceiver automatically repeats the call 3 times (default), and "WAIT" is displayed during each call. However, an error beep sounds and "FAIL" is displayed when no answer back is received after the calls.

- ⑦ Push [PTT] to transmit, release to receive.
- ⑧ Push [P3] (Moni(Audi)) to send the "Clear down" signal.

For your information

When the "UpDate" setting for the call code is enabled, the set code is overwritten into the call code memory.

■ Receiving a message

◇ Receiving a status message

- ① When a status message is received;
 - Beeps sound.
 - The calling station ID (or text) and the status message is displayed alternately, depending on the setting.

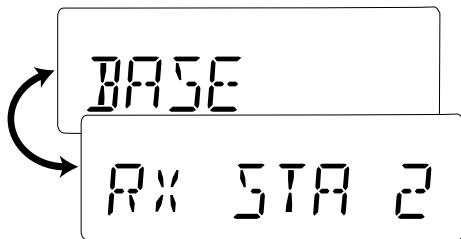

- ② Push [P3] (Moni(Audi)) to return to the standby condition.

NOTE: Only the calling station ID (or text) is displayed (no message is displayed alternately) when the scroll timer is set to "OFF". In this case, push [Status Up]/[Status Down] to display the status message manually.

4 BIIS OPERATION

◇ Receiving an SDM

- ① When an SDM is received;
 - Beeps sound.
 - The calling station ID (or text) and the SDM is displayed alternately, depending on the setting.

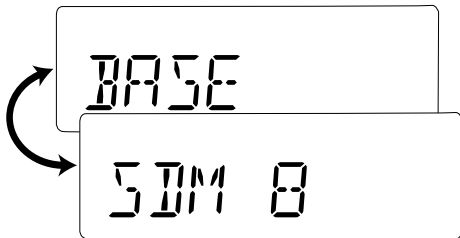

- ② When the received SDM includes more than 8 characters, the message scrolls automatically, when the automatic scroll function is activated.
 - Push [Status Up]/[Status Down] to scroll the message manually.
- ③ Push [P3] (Moni(Audi)) to return to the standby condition.

◇ Received message selection

The transceiver memorizes the received messages for record. Up to 6 messages for status and SDM, or 95 character SDM's can be memorized. The oldest message is erased when the 7th message is received. However, once the transceiver is powered OFF, all messages are cleared.

- ① Hold down [P1] (Digital) for 1 second.
 - Displays queue memory.
- ② Push [P1] (Digital) momentarily.
 - Displays message memory.

When a message is available

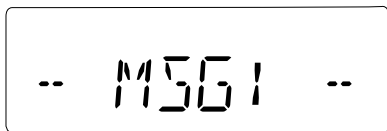

When no message is available

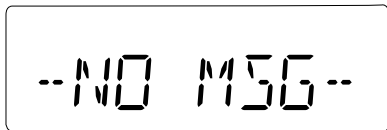

- ③ Push [▼]/[▲] to select the desired message.
 - When selecting the SDM that includes more than 8 characters, the message scrolls automatically, when the automatic scroll function is activated.
 - Push [Status Up]/[Status Down] to scroll the message manually.
- ④ Hold down [P1] (Digital) for 1 second again to return to the standby condition.
 - When no operation is performed for 30 seconds, the transceiver automatically returns to the standby condition.

■ Transmitting a status

◇ General

The status message can be selected with the programmed text, and the message text is also displayed on the function display of the called station.

Up to 24 status types (1 to 24) are available, and the status messages 22 and 24 have designated meanings.

Status 22: Emergency*

Status 24: GPS request

*The status 22 can also be used as a normal status message by disabling the designated meaning. However, the status 24 is fixed.

The status call can be sent with both individual and group calls.

◇ Transmitting a status

- ① While in the standby condition, push [P1] (Digital), then push [▼]/[▲] to select the desired station/group code.
- ② Push [P1] (Digital) again, then push [▼]/[▲] to select the desired status message.

Or, you can select the desired status message using [Status Up]/[Status Down] key directly.

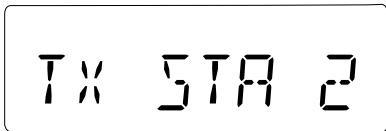

Status message is displayed.

- ③ Push [P0] (Call) or [PTT]* to transmit the status message to the selected station/group.

*PTT call can be made only when PTT call capability is permitted.

- 2 beeps will sound and the transceiver returns to the standby condition automatically when the transmission is successful.

■ Transmitting an SDM

◇ General

The short data message, SDM, can be sent to an individual station or group stations. Also, 8 SDM memory channels are available and the messages can be edited via PC programming.

4

◇ Transmitting an SDM

- ① While in the standby condition, push [P1] (Digital), then push [▼]/[▲] to select the desired station/group code.
- ② Push [P1] (Digital) again, then push [▼]/[▲] to select the desired SDM.

Or, you can select the desired SDM using [Status Up]/[Status Down] key directly.



SDM is displayed.

- ③ Push [P0] (Call) or [PTT]* to transmit the SDM to the selected station/group.
 - *PTT call can be made only when PTT call capability is permitted.
 - 2 beeps will sound and the transceiver returns to the standby condition automatically when the transmission is successful.

■ Position data transmission

When the optional OPC-966 INTERFACE CABLE and a GPS receiver is connected to the transceiver, the position (longitude and latitude) data can be transmitted automatically.

Ask your dealer or system operator for connection details.

The position data is transmitted when;

- Status 24 message is received
*When the status 24 message, GPS request, is received.

- Fully automatic

When automatic position transmission is enabled, send the position data according to 'Time Marker' and 'Interval Timer' settings.

- PTT is released

When 'Send with Logoff' is enabled.

- Set the "Log-In/Off" item as "L-OFF".

- After sending a status message

When 'Send with Status' is enabled.

- After sending an SDM

When 'Send with SDM' is enabled.

- After sending status 22 (Emergency)

When 'Send with Emergency' is enabled.

■ Printer connection

When the optional OPC-966 INTERFACE CABLE is connected to the transceiver, a printer can be connected to print out the received SDM content and the ID of the station who sent the message.

Ask your dealer or system operator for connection details.

4

■ PC connection

When the optional OPC-966 INTERFACE CABLE is connected to the transceiver, a PC can be connected to provide remote control, data reception, etc.

Ask your dealer or system operator for connection details.

■ Digital ANI

The own ID can be transmitted each time the PTT is pushed (log-in) or released (log-off) during individual or group call communications.

By receiving the ANI, the communication log can be recorded when using a PC dispatch application.

In addition, when using the ANI with log-in, the PTT side tone function can be used to inform you that the ID is sent and voice communication can be performed.

■ Auto emergency transmission

When [Emergency Single (Silent)] or [Emergency Repeat (Silent)] is pushed, an emergency signal is automatically transmitted for the specified time period.

The status 22 (Emergency) is sent to the selected ID station, and the position data is transmitted after the emergency signal when a GPS receiver is connected to the transceiver.

The emergency transmission is performed on the emergency channel, however, when no emergency channel is specified, the signal is transmitted on the previously selected channel.

There is no change in the function display or beep emission during automatic emergency transmission.

■ Stun function

When the specified ID, set as a killer ID, is received, the stun function is activated.

When the killer ID is received, the transceiver switches to the passcode required condition. Entering of the passcode via the keypad is necessary to operate the transceiver again in this case.

■ BIIS indication

The following indicators are displayed for BIIS operation on an MSK channel.

CONNECT : Individual/group call is successful.

OK : Message (status or SDM) transmission is successful.

FAILED : No answer back is received.

WAIT : Appears during retry of the call (2nd call).

CLR DOWN: End the communication.

BUSY : Operating channel is busy.

4

■ Priority A channel selection

When one of the following operations is performed, the transceiver selects the Priority A channel automatically.

Priority A is selected when:

- Clear down signal is received/transmitted
 - Set the “Move to PrioA CH” item as “Clear Down”.
- Turning the power ON
 - The Priority A channel is selected each time the transceiver power is turned ON.
- Status call
 - The Priority A channel is selected when transmitting a status call.
 - Enable the “Send Status on PrioA CH” item in the MSK configuration.

5 BATTERY CHARGING

■ Caution

Misuse of Lithium-ion batteries may result in the following hazards: smoke, fire, or the battery may rupture. Misuse can also cause damage to the battery or degradation of battery performance.

 **WARNING! NEVER** charge the battery (with/without the transceiver) in an explosive atmosphere. The optional battery chargers are not approved as Intrinsically Safe.

◇ Battery caution

 **DANGER! NEVER** strike or otherwise impact the battery pack. Do not use the pack if it has been severely impacted or dropped, or if it has been subjected to heavy pressure. Battery damage may not be visible on the outside of the case. Even if the surface of the pack does not show cracks or any other damage, the cells inside the pack may rupture or catch fire.

 **DANGER! NEVER** use the transceiver or the battery if either one is damaged, shows cracks, bruises or is deformed.

 **DANGER! NEVER** leave the battery pack in places with temperatures above +60°C. High temperature buildup in the battery cells, such as could occur near fires or stoves, inside a sun-heated vehicle, or in direct sunlight for long periods of time may cause the battery cells to rupture or catch fire. Excessive temperatures may also degrade pack's performance or shorten the battery cell's life.

⚠ **DANGER! NEVER** expose the battery pack to rain, snow, seawater, or any other liquids. Do not charge or use a wet battery pack. If the pack gets wet, be sure to wipe it dry before using. The battery pack itself is not waterproof.

⚠ **DANGER! NEVER** place battery packs near a fire. Fire or heat may cause them to rupture or explode. Dispose of used packs in accordance with local regulations.

⚠ **DANGER! NEVER** solder the battery cell's terminals, and **NEVER** modify the battery pack. This may cause heat generation, and the battery cells may burst, emit smoke or catch fire.

⚠ **DANGER! NEVER** use the battery pack with a transceiver for which it is not specified. Never use a pack with any other equipment, or for any purpose that is not specified in this instruction manual.

⚠ **DANGER! NEVER** let fluid from inside the battery cells get in your eyes. If it does, blindness can result. Rinse your eyes with clean water, without rubbing them, and immediately go to a doctor.

⚠ **WARNING! NEVER** use the battery pack if it emits an abnormal odor, heats up, or is discolored or deformed. If any of these conditions occur, contact your Icom dealer or distributor.

⚠ **WARNING! NEVER** let fluid from inside the battery cells come in contact with your body. If it does, immediately wash with clean water.

⚠ **WARNING! NEVER** put the battery pack in a microwave oven, high-pressure container, or in an induction heating cooker. This could cause a fire, overheating, or cause the battery cells to rupture.

➡ Continue to the next page.

5 BATTERY CHARGING

■ Caution

◇ Battery caution (Continued)

CAUTION: DO NOT use the battery pack out of the specified temperature range for the transceiver (-20°C to $+55^{\circ}\text{C}$) and the pack itself (-10°C to $+60^{\circ}\text{C}$). Using the pack out of its specified temperature range will reduce its performance and the battery cell's life. Please note that the specified temperature range of the pack may exceed that of the transceiver. In such cases, the transceiver may not work properly because it is out of its operating temperature range.

CAUTION: Shorter battery pack life could occur if the pack is left fully charged, completely discharged, or in an excessive temperature environment (above $+45^{\circ}\text{C}$) for an extended period of time. If the battery pack must be left unused for a long time, it must be detached from the transceiver after discharging. You may use the pack until the remaining capacity is about half, then keep it safely in a cool dry place in the following temperature range:

- -20°C to $+45^{\circ}\text{C}$ (within a month)
- -20°C to $+40^{\circ}\text{C}$ (within six months)
- -20°C to $+35^{\circ}\text{C}$ (within a year)

BE SURE to replace the battery pack with a new one approximately five years after manufacturing, even if it still holds a charge. The material inside the battery cells will become weak after a period of time, even with little use. The estimated number of times you can charge the pack is between 300 and 500. Even when the pack appears to be fully charged, the operating time of the transceiver may become short when:

- Approximately five years have passed since the pack was manufactured.
- The pack has been repeatedly charged.

◇ Charging caution

⚠ **DANGER! NEVER** charge the battery pack in areas with extremely high temperatures, such as near fires or stoves, inside a sunheated vehicle, or in direct sunlight. In such environments, the safety/protection circuit in the pack will activate and stop the charging.

⚠ **DANGER! NEVER** charge the transceiver during a lightning storm. It may result in an electric shock, cause a fire or damage the transceiver. Always disconnect the power adapter before a storm.

⚠ **WARNING! NEVER** charge or leave the battery pack in the battery charger beyond the specified time for charging. If the pack is not completely charged by the specified time, stop charging and remove it from the battery charger. Continuing to charge the pack beyond the specified time limit may cause a fire, overheating, or the battery cells may rupture.

⚠ **WARNING! NEVER** insert the transceiver (with the battery pack attached) into the charger if it is wet or soiled. This could corrode the battery charger terminals or damage the charger. The charger is not waterproof.

⚠ **WARNING! NEVER** charge the transceiver during a lightning storm. It may result in an electric shock, cause a fire or damage the transceiver. Always disconnect the power adapter before a storm.

CAUTION: DO NOT charge the battery outside of the specified temperature range: BC-152N (+10°C to +45°C). Icom recommends charging the battery at +20°C. The battery may heat up or rupture if charged out of the specified temperature range. Additionally, battery performance or battery life may be reduced.

■ Optional battery chargers

◇ Regular charging with the BC-152N

- ① Attach the BC-152N to a flat surface, such as a desk, if desired.
- ② Connect the power adapter as shown below.
- ③ Insert the battery pack with/without the transceiver into the charger.
 - The charge indicator lights orange.
- ④ Charge the battery pack approximately 10 hours, depending on the remaining battery power.
 - The charge indicator lights green after charging is complete.

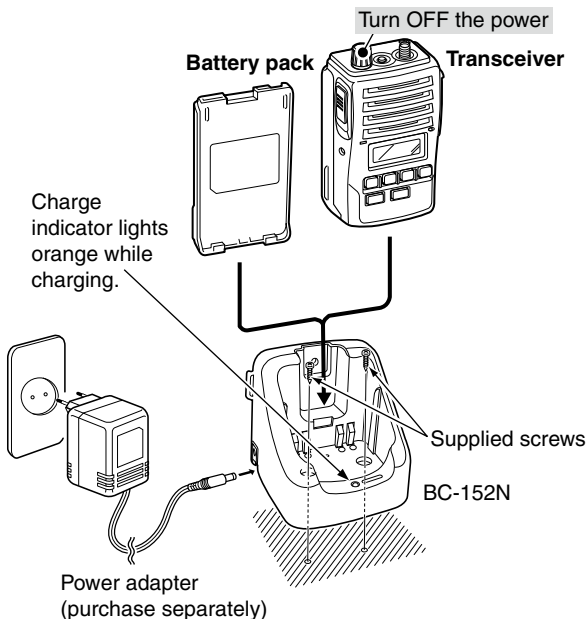

○ Charging indicator:

- Lights orange while charging.
- Lights green after charging is completed.
- Blinks orange or green, or does not light when a problem is detected.

SOLUTIONS:

- Remove the battery pack, and reinsert it.
- Remove the battery pack, clean the battery terminals, then reinsert it.
- If the battery pack temperature is high, remove and let it cool down, then reinsert it.

If you are unable to solve the problem through the use of these solutions, the battery pack or the charger may be damaged, or the battery life may be over. In that case, contact your nearest Icom Dealer or Service Center.

NOTE:

After charging is completed, the BC-152N will automatically recharge the battery pack when the battery voltage decreases. If the battery pack is often left in the charger for long periods, the battery life cycle will be shorter.

◇ For your convenience

Eyelet
USE a rubber band to secure the transceiver while charging, if desired.

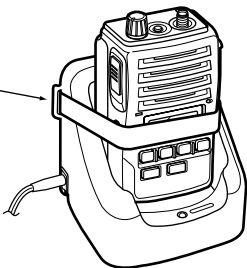

5 BATTERY CHARGING

■ Optional battery chargers (Continued)

◇ AD-100 installation

The AD-100 CHARGER ADAPTER must be installed into the BC-119N or BC-121N before battery charging.

- ① Connect the AD-100 CHARGER ADAPTER and the BC-119N or BC-121N.
- ② Install the AD-100 into the holder space of the BC-119N or BC-121N with the supplied screws.

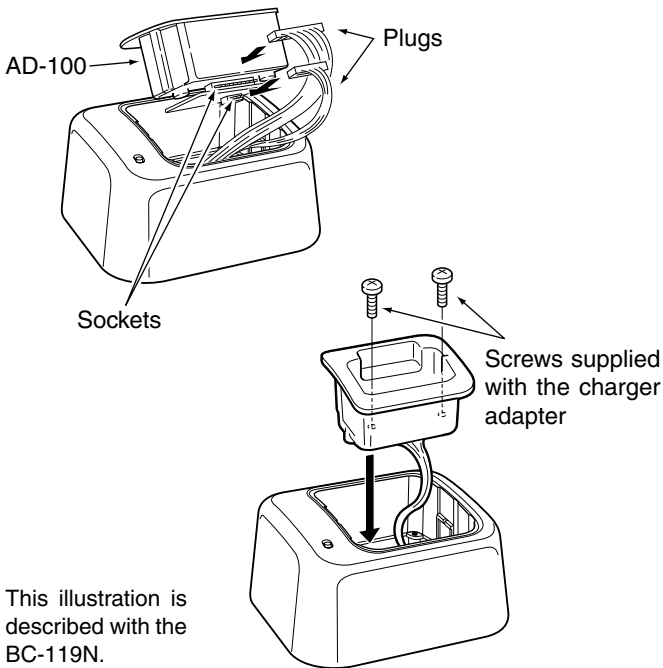

This illustration is described with the BC-119N.

◇ Rapid charging with the BC-119N+AD-100

The optional BC-119N provides rapid charging of Li-ion battery pack.

The following are additionally required:

- One AD-100 (purchase separately)
- A power adapter (may be supplied with BC-119N depending on version) or the DC power cable (OPC-515L/CP-23L).

5

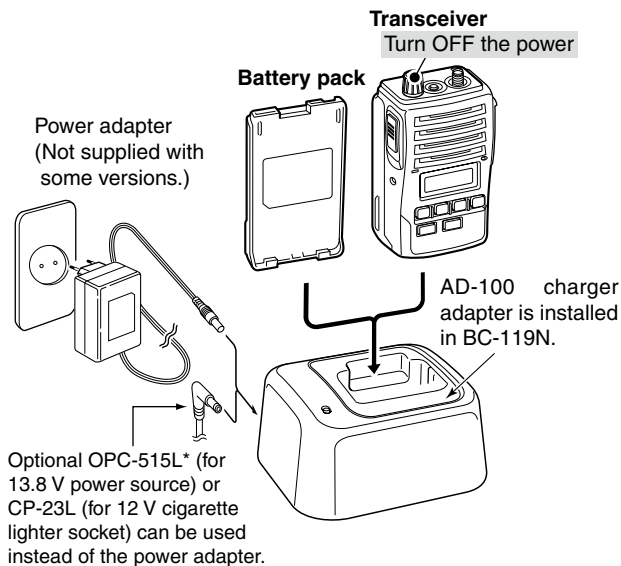

***CAUTION: NEVER** connect the OPC-515L to a power source using reverse polarity. This will ruin the battery charger.
 // White line: ⊕ Black line: ⊖

5 BATTERY CHARGING

■ Optional battery chargers (Continued)

◇ Rapid charging with the BC-121N+AD-100

The optional BC-121N allows up to 6 battery packs to be charged simultaneously. The following are additionally required.

- Six AD-100 (purchase separately)
- A power adapter (BC-157) or the DC power cable (OPC-656)

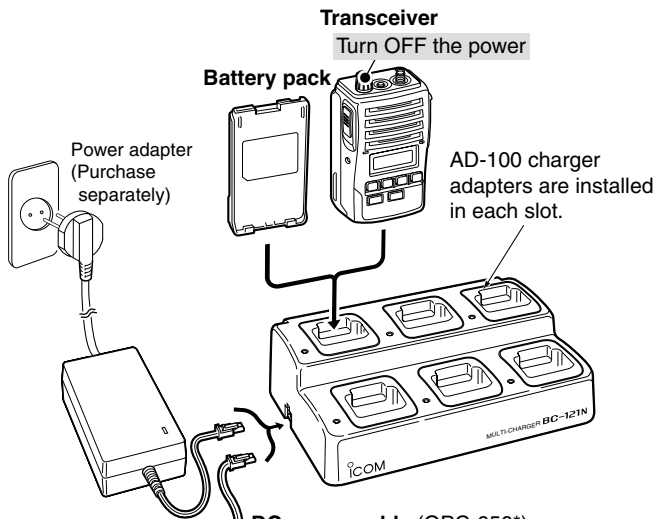

DC power cable (OPC-656*)

(Connect with a DC power source:
13.8 V/at least 7 A)

/// *CAUTION: NEVER connect the OPC-656 to a power source using reverse polarity. This will ruin the battery charger.

/// Red line: ⊕ Black line: ⊖

IMPORTANT: Battery charging caution

Ensure the guide tabs on the battery pack are correctly aligned with the guide rails inside the charger adapter.
(This illustration shows the BC-152N.)

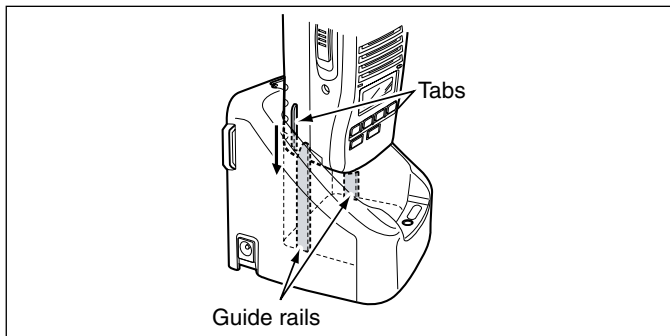

6 SPEAKER-MICROPHONE

■ Optional HM-138 description

Alligator type clip
To attach the speaker-mic.
to your shirt or collar, etc.

PTT switch
Transmits while pushed
Receives while released

Microphone

Speaker

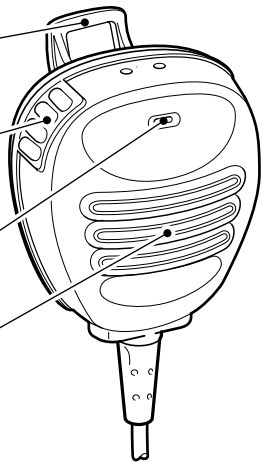

NEVER immerse the connector in water. If the connector becomes wet, be sure to dry it **BEFORE** attaching it to the transceiver.

NOTE: The microphone is located at the top of the speaker-microphone, as shown in the diagram above. To maximize the readability of your transmitted signal (voice), hold the microphone approx. 5 to 10 cm from your mouth, and speak in a normal voice level.

■ Attachment

Attach the connector of the speaker-microphone into the [SP MIC] connector on the transceiver and tighten the screw.

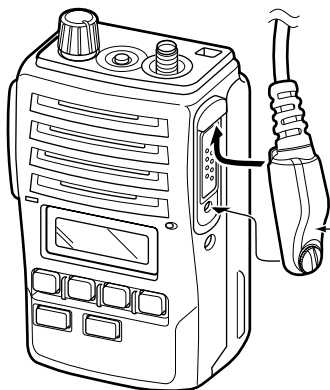

CAUTION: Attach the speaker-microphone's connector securely to prevent accidental dropping, or water intrusion in the connector.

IMPORTANT: KEEP the [SP MIC] jack cover attached (transceiver) when the speaker-microphone is not in use. Water will not get into the transceiver even if the cover is not attached, however, the terminals (pins) will become rusty, or the transceiver will function abnormally if the connector becomes wet.

CAUTION: For ATEX compliance in hazardous areas, the jack cover just also be attached when the HM-138 is not being used.

7 OPTIONS

- **BP-227AX** Li-Ion BATTERY PACK
7.4 V/1850 mAh/14 Wh Li-ion battery pack. The same as supplied with the transceiver. BP-227AX must be charged with the optional BC-152N or the BC-119N/121N.
- **BC-152N** DESKTOP CHARGER + **BC-147S** AC ADAPTER
Used for regular charging of the battery pack. The power adapter, BC-147S, must be purchased separately.
Charging time: Approximately 9 to 10 hours
- **BC-119N** DESKTOP CHARGER + **AD-100** CHARGER ADAPTER + **BC-145S** AC ADAPTER
For rapid charging of battery packs. A power adapter is not supplied with some versions.
Charging time: Approximately 2 to 2.5 hours
- **BC-121N** MULTI-CHARGER + **AD-100** CHARGER ADAPTER (6 pcs.) + **BC-157S** AC ADAPTER
For rapid charging of up to 6 battery packs (six AD-100's are required) simultaneously. A power adapter should be purchased separately.
Charging time: Approximately 2 to 2.5 hours
- **HM-138** SPEAKER-MICROPHONE
Full-sized speaker-microphone including alligator type clip to attach to your shirt or collar, etc.
- **MB-98** BELT CLIP
- **MB-86** SWIVEL BELT CLIP
- **MB-96F** LEATHER BELT HANGER
- **FA-S62VS/FA-S63VS/FA-S57US** STUBBY ANTENNA
FA-S62VS: 150–162 MHz FA-S63VS: 160–174 MHz
FA-S57US: 450–490 MHz

Some options may not be available in some countries. Please ask your dealer for details.

8 ATEX CAUTIONS

◇ Special conditions for safe use

The equipment is an intrinsically safe equipment. It can be used in a potentially explosive atmosphere.

The equipment must be powered only by the battery Icom type BP-227AX.

When the transceiver is used in a hazardous areas, either the jack cover or HM-138 must be attached to the connector. Failure to do this will make the transceiver ATEX non-compliant and may result in an accident during use in hazardous areas.

The battery shall be charged only in non hazardous areas.

The battery shall be changed only in non hazardous areas.

Ambient operating temperature: -20°C to $+55^{\circ}\text{C}$

◇ Typical output parameters

$$U_o = 8.8 \text{ V}$$

$$I_{\text{permanent}} = 1.7 \text{ A}$$

$$P_o = 14.95 \text{ W}$$

$$C_o = 65 \mu\text{F}$$

$L_o = 25 \mu\text{H}$ under the following conditions:

- The added microphone/speaker/headset must be installed and screwed on the radio's connector.
- The internal resistance of the added microphone/speaker/headset should be equivalent to a value at minimum 7.2Ω .

• Applicable standards

EN IEC 60079-0: 2018

EN 60079-11: 2012

Markings

- For models IC-F51 and IC-F61 with HM-138 microphone:

⊕ II 2 G

Ex ib IIA T3 Gb

LCIE 04 ATEX 6184 X, LCIE 05 ATEX 6046 X

Ambient temperature: -20°C to $+55^{\circ}\text{C}$

WARNING – DO NOT CHARGE THE BATTERY IN HAZARDOUS LOCATION.

- For models IC-F51 and IC-F61 without HM-138 microphone:

⊕ II 2 (2) G

Ex ib [ib Gb] IIA T3 Gb

U_0 : 8.8 V, $I_{\text{permanent}}$: 1.7 A, P_0 : 14.95 W, C_0 : 65 μF , L_0 : 25 μH^*

LCIE 04 ATEX 6184 X, LCIE 05 ATEX 6046 X

Ambient temperature: -20°C to $+55^{\circ}\text{C}$

WARNING – DO NOT CHARGE THE BATTERY IN HAZARDOUS LOCATION.

- * Under the following conditions:

- The added microphone/speaker/headset must be installed and screwed on the radio's connector.
- The internal resistance of the added microphone/speaker/headset should be equivalent to a value at minimum 7.2Ω .

◇ Meaning of ATEX marking codes

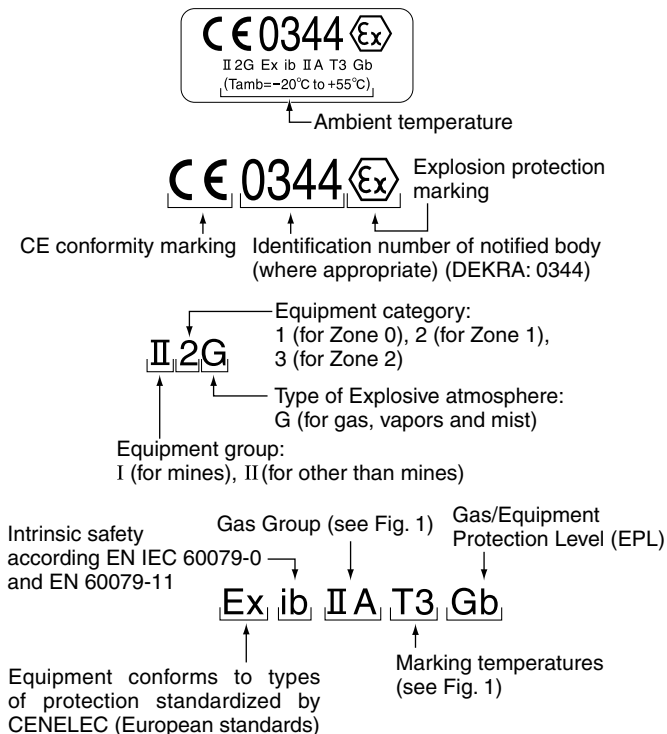

		Max. Temperature						
		T1: 450°C	T2: 300°C	T3: 200°C	T4: 135°C	T5: 100°C	T6: 85°C	
I	Methane	—	—	—	—	—	—	
	Acetone	Ethyl alcohol	Benzene	Acetalde hyde	—	—	—	
	Ethane	I-amyl acetate	Diesel fuel	Ethyl ether	—	—	—	
	Ethyl acetate	n-butane	Aircraft fuel	—	—	—	—	
IIA	Ammonia	n-butyl alcohol	Heating oil	—	—	—	—	
	Benzene (pure)	—	n-hexane	—	—	—	—	
	Acetic acid	—	—	—	—	—	—	
	Carbon Monoxide	—	—	—	—	—	—	
	Methanol	—	—	—	—	—	—	
	Propane	—	—	—	—	—	—	
	Toluene	—	—	—	—	—	—	
IIB	Town Gas (Coal Gas)	Ethylene	—	—	—	—	—	
	IIC	Hydrogen	Acetylene	—	—	Carbon disulphide	Ethyl nitrate	

(Fig. 1)

9 INFORMATION

■ About CE and DOC



Hereby, Icom Inc. declares that the versions of IC-F51/IC-F61 which have the “CE” symbol on the product, comply with the essential requirements of the Radio Equipment Directive, 2014/53/EU, and the restriction of the use of certain hazardous substances in electrical and electronic equipment Directive, 2011/65/EU. The full text of the EU declaration of conformity is available at the following internet address:

<https://www.icomjapan.com/support/>

The EU declaration of conformity of the ATEX Directive, 2014/34/EU is included in the box.

■ Disposal



The crossed-out wheeled-bin symbol on your product, literature, or packaging reminds you that in the European Union, all electrical and electronic products, batteries, and accumulators (rechargeable batteries) must be taken to designated collection locations at the end of their working life. Do not dispose of these products as unsorted municipal waste. Dispose of them according to the laws in your area.

