



motorola

MOTOROLA PIP10

DIGITAL AUDIO BABY MONITOR



For: PIP10
User Guide

Safety instructions

WARNING

Strangulation Hazard. Children have STRANGLED in cords. Keep this cord out of the reach of children (more than 1 metre away). Never use extension cords with AC Adaptors. Only use the AC Adaptors provided.

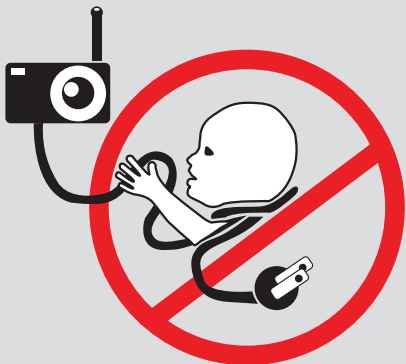

Baby monitor setup and use:

- Determine a location for the baby unit that will allow you to hear your baby in his/her cot.
- Place the baby unit on a flat surface, such as a dresser, bureau, or shelf or mount the unit to a wall securely using the keyhole slots under the stand.
- NEVER place the baby unit or cords within the cot.

WARNING

This digital audio baby monitor is compliant with all relevant standards regarding electromagnetic fields and is, when handled as described in the User Guide, safe to use. Therefore, always read the instructions in this User Guide carefully before using the device.

- Adult assembly is required. Keep small parts away from children when assembling.
- This product is not a toy. Do not allow children to play with it.
- This digital audio baby monitor is not a substitute for responsible adult supervision.
- Keep this User Guide for future reference.
- Keep the cords out of reach of children.
- Do not cover the digital audio baby monitor with a towel or blanket.
- Test this monitor and all its functions so that you are familiar with it prior to actual use.
- Do not use the digital audio baby monitor in damp areas or close to water.
- Do not install the digital audio baby monitor in extreme cold or heat, direct sunlight, or close to a heat source.
- Do not touch the plug contacts with sharp or metal objects.
- Connect the power adaptors to easily accessible mains power.

CAUTION

There is a risk of explosion if the battery is replaced by an incorrect type. Dispose of used batteries according to the instructions.

Welcome...

to your new Motorola PIP10 Audio Baby Monitor!

- Secure, interference free reception and high-quality sound.
- Long range up to 160 feet indoors and 1000 feet outdoors.
- Microphone with high sensitivity.
- Battery powered portable parent unit.
- Expandable up to 2 parent units.
- Parent unit with mute function and alert indicator.
- Out of range and low battery alarm.

Need help?

If you have any problems setting up or using your PIP10, please visit us at motorolanursery.com/support.

Alternatively, you may find the answer in the 'Help' section at the back of this guide.

This User Guide provides you with all the information you need to get the most from your digital audio baby monitor.

Read the instructions carefully, and be aware that this digital audio baby monitor is only intended as an aid. It is not a substitute for responsible and proper adult supervision.

Before you use the digital audio baby monitor, set up the parent and baby units. Follow the simple instructions in 'Getting started', on the next few pages.

Important

Only use the power adaptors supplied.

Got everything?

- Parent unit
- Baby unit
- AC power adaptor for the parent unit
- AC power adaptor for the baby unit

If you have purchased PIP10 dual parent units, you will also have the following additional items:

- Parent unit
- AC power adaptor for the parent unit

1.	Getting started	7
2.	Getting to know your baby monitor	10
3.	Using the digital audio baby monitor	12
3.1	Turn the baby unit on / off.....	12
3.2	Turn the parent unit on / off.....	12
3.3	Adjust the speaker volume on the parent unit.....	12
3.4	Mute the speaker.....	12
3.5	Sound alert	12
4.	Help.....	13
5.	Technical Specifications.....	14
6.	General information	15

1. Getting started

Location

Important

Do not place your **PIP10** in the bathroom or other humid areas.

Place your units within reach of the AC power outlet and wall socket. The socket-outlet should be installed near the equipment and should be easily accessible.

Range of parent and baby units

Make sure the distance between the parent unit and baby unit is less than 300 metres.

Setting up

Important

The baby unit must be plugged into the AC power at all times. Use only the AC power adaptor supplied with the product.

Connecting the baby unit

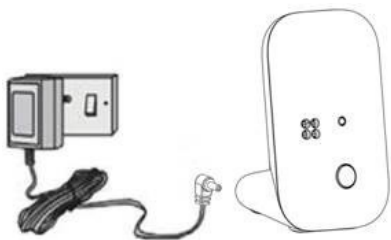

1. Plug the DC plug of the power adaptor into the DC jack on the rear of the baby unit and plug the other end of the AC adaptor into the AC power outlet.
2. Switch on the AC power.

Installing batteries (not supplied) into the parent unit

1. Lift up the battery cover to remove it from the the parent unit.

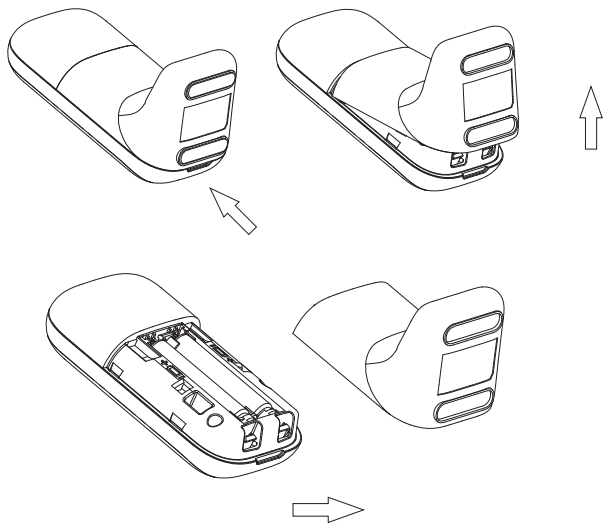

2. Insert the battery cells (not supplied). Note the '+' and '-' markings inside the battery compartment and insert in the correct direction.
3. Slide the battery cover back into place.

Note

You can either purchase non-rechargeable battery cells (2 x AAA batteries) or rechargeable NIMH battery cells (2 x AAA batteries) for the parent unit.

Connecting the parent unit

You will need to carry out this process for the single or dual parent units.

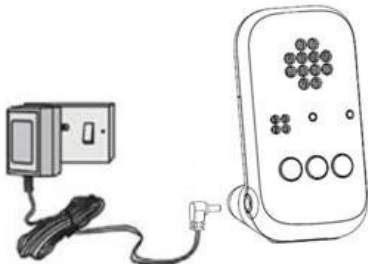

1. Plug the DC plug of the power adaptor into the DC jack on the side of the parent unit and plug the other end of the AC adaptor into the AC power outlet.
2. Switch on the AC power. The parent unit turns on.

Note

The parent unit will not start charging if rechargeable NIMH battery cells are installed.

Your PIP10 is now ready for use.

2. Getting to know your baby monitor

Overview of your baby unit

Front view

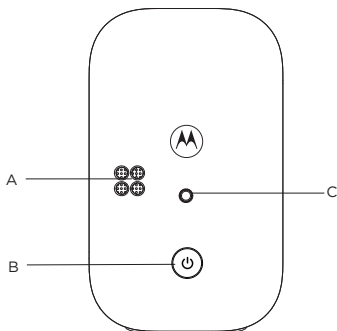

Back view

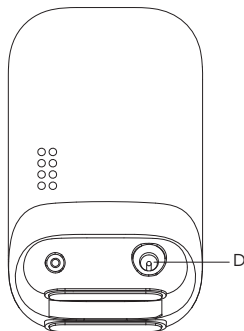

A Microphone

B Power button

Press and hold to turn the baby unit on or off.

C Power / Linking LED indicator

Turns on when the parent unit is powered on and linked to the baby unit.

D Power jack

Overview of your parent unit

Front view

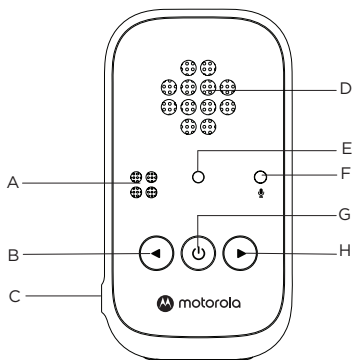

Back view

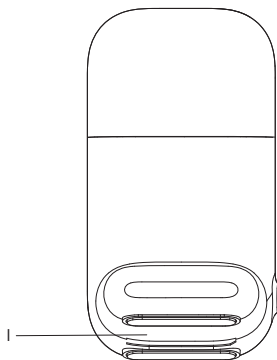

A Microphone

B Volume up

Press to increase the speaker volume.

C Power jack

D Speaker

E Power / Linking LED indicator

Turns on when the parent unit is powered on and linked to the baby unit.
Flashes when the parent and baby units are not linked with each other.

F Mute / Sound alert indicator (red LED)

G Power button

Press and hold to turn the parent unit on or off.



H Volume down / Mute

Press to decrease the speaker volume or scroll down in screen.
Press and hold to mute the speaker.



I Battery compartment

3. Using the digital audio baby monitor

3.1 Turn the baby unit on / off

- Press and hold  on the baby unit to turn it on. The power / linking LED indicator will turn on.
- Press and hold  on the baby unit again to turn it off. The power / linking LED indicator will turn off.

3.2 Turn the parent unit on / off



- Press and hold  on the parent unit to turn it on. The power / linking LED indicator will turn on.
- Press and hold  on the parent unit again to turn it off. The power / linking LED indicator will turn off.

Note

If you place the parent and baby units too close together, you may hear a high pitched noise. This is not a fault. The units are designed to be operated at some distance apart, e.g. in separate rooms, so move the units further apart.

If the power / linking LED indicator flashes on the parent unit, they are not linked to each other. Make sure that both units are powered on, and the distance between the parent and baby units is less than 300 metres.

3.3 Adjust the speaker volume on the parent unit

Press  or  to increase or decrease the volume.

3.4 Mute the speaker

Press and hold  to mute the speaker. The mute / sound alert indicator will turn on.

3.5 Sound alert

The parent unit beeps when a loud sound is detected by the baby unit. The mute / sound alert indicator will flash. This feature is only available when the speaker of the parent unit is muted.

4. Help

The power / linking LED Indicator on the parent unit does not turn on.

- Check whether the parent unit is powered on.
- Check whether the batteries are correctly installed and not drained.
- Connecting the parent unit to the mains power to recharge it.

The power / linking LED indicator on the parent unit flashes.

- The parent unit and the baby unit may be out of range with each other. Reduce the distance between the units, but not closer than 300 metres.
- The baby unit may be powered off. Press and hold  on the baby unit to power it on.

The parent unit beeps.

- The parent unit may have lost connection with the baby unit. Make sure the distance between the parent unit and baby unit is less than 300 metres.
- The baby unit may be powered off. Press and hold  on the baby unit to power it on.

Unable to hear the sound or baby cry from the parent unit.

- The volume level in the parent unit may be set too low. Increase the volume level of the parent unit. Refer to **section 3.3** for volume level settings.
- The parent unit and the baby unit may be out of range with each other. Make sure the distance between the parent unit and baby unit is less than 300 metres.

The Digital Audio Baby Monitor system produces a high-pitched noise.

- The parent unit and the baby unit are too close with each other. Make sure the distance between the parent unit and baby unit is less than 300 metres.
- The speaker volume of the parent unit may be set too high. Decrease the volume of the parent unit. Refer to **section 3.3** for volume level settings.

5. Technical Specifications

RF frequency bands	1881.792 MHz to 1897.344 MHz (Europe) 1921.536 MHz to 1928.448 MHz (USA & Canada)
RF transmission power	< 0.25 W (EU version)
Line of sight operating range between the baby and parent units	300 meters
Power adaptor for the baby and parent units	DC 6.0V, 0.4A with DC round plug from: Dongguan Everest Industrial Co., Ltd. Address: No.2, Min Xing 1st Road, Shang Jiao, Chang An Town, Dong Guan, GuangDong, China. <ul style="list-style-type: none">• EP19-060040WXLA for USA and Canada• EP19A-060040WXEZ for Europe OR Shenzhen Huajin Electron Co., Ltd. Address: Block E, Xing Zhongqiao Industrial Park, Baolong Six Road, BaoLong Industrial City, Longgang District, 518116 ShenZhen, China. <ul style="list-style-type: none">• HJ-0600400A1-US for USA and Canada• HJ-0600400P1-EU for Europe
ECO friendly Voice-activation (VOX feature)	Parent unit <ul style="list-style-type: none">• enters monitor mode when sound level is higher than 60dBAspl.• enters standby mode when sound level is lower than 60dBAspl.

Note

Specifications are subject to change without prior notice.

6. General information

Cleaning and care

Important

Always switch off and disconnect the power adaptor before cleaning your digital audio baby monitor.

- Clean your digital audio baby monitor with a slightly damp cloth or with an anti-static cloth. Never use cleaning agents or abrasive solvents.
- Do not clean any part of the digital audio baby monitor with thinners or other solvents and chemicals - this may cause permanent damage to the product which is not covered by the warranty.
- Keep your digital audio baby monitor away from hot, humid areas or strong sunlight, and do not let it get wet.
- Every effort has been made to ensure high standards of reliability of your digital audio baby monitor. However, if something does go wrong, please do not try to repair it yourself - contact Customer Service for assistance.

Disposal of the Device (environment)

At the end of the product life cycle, you should not dispose of this product with normal household waste. Take this product to a collection point for the recycling of electrical and electronic equipment. The symbol on the product, user guide and/or box indicates this. Some of the product materials can be re-used if you take them to a recycling point. By reusing some parts or raw materials from used products you make an important contribution to the protection of the environment. Please contact your local authorities in case you need more information on the collection points in your area. Dispose of the battery pack in an environmentally-friendly manner according to your local regulations.



Consumer Products and Accessories Warranty

Thank you for purchasing this Motorola branded product manufactured under license by Meizhou Guo Wei Electronics Co. LTD., AD1 section, The economy exploitation area, Meizhou, Guangdong, P.R.China . ("MZGW")

What Does this Warranty Cover?

Subject to the exclusions contained below, MZGW warrants that this Motorola branded product ("Product") or certified accessory ("Accessory") sold for use with this product that it manufactured to be free from defects in materials and workmanship under normal consumer usage for the period outlined below. This Limited Warranty is your exclusive warranty and is not transferable.

Who is covered?

This warranty extends only to the first consumer purchaser, and is not transferable.

What will MZGW do?

MZGW or its authorized distributor at its option and within a commercially reasonable time, will at no charge repair or replace any Products or Accessories that do not conform to this limited warranty. We may use functionally equivalent reconditioned / refurbished / pre-owned or new Products, Accessories or parts.

What Other Limitations Are There?

ANY IMPLIED WARRANTIES, INCLUDING WITHOUT LIMITATION THE IMPLIED WARRANTIES OF MERCHANTABILITY AND FITNESS FOR A PARTICULAR PURPOSE, SHALL BE LIMITED TO THE DURATION OF THIS LIMITED WARRANTY, OTHERWISE THE REPAIR OR REPLACEMENT PROVIDED UNDER THIS EXPRESS LIMITED WARRANTY IS THE EXCLUSIVE REMEDY OF THE CONSUMER, AND IS PROVIDED IN LIEU OF ALL OTHER WARRANTIES, EXPRESS OF IMPLIED. IN NO EVENT SHALL MOTOROLA OR MZGW BE LIABLE, WHETHER IN CONTRACT OR TORT (INCLUDING NEGLIGENCE) FOR DAMAGES IN EXCESS OF THE PURCHASE PRICE OF THE PRODUCT OR ACCESSORY, OR FOR ANY INDIRECT, INCIDENTAL, SPECIAL OR CONSEQUENTIAL DAMAGES OF ANY KIND, OR LOSS OF REVENUE OR PROFITS, LOSS OF BUSINESS, LOSS OF INFORMATION OR OTHER FINANCIAL LOSS ARISING OUT OF OR IN CONNECTION WITH THE ABILITY OR INABILITY TO USE THE PRODUCTS OR ACCESSORIES TO THE FULL EXTENT THESE DAMAGES MAY BE DISCLAIMED BY LAW.

Some jurisdictions do not allow the limitation or exclusion of incidental or consequential damages, or limitation on the length of an implied warranty, so the above limitations or exclusions may not apply to you. This warranty gives you specific legal rights, and you may also have other rights that vary from one jurisdiction to another.

Products Covered	Length of Coverage
Consumer Products	Two (2) years from the date of the products original purchase by the first consumer purchaser of the product.
Consumer Accessories	Ninety (90) days from the date of the accessories original purchase by the first consumer purchaser of the product.
Consumer Products and Accessories that are Repaired or Replaced	The balance of the original warranty or for ninety (90) days from the date returned to the consumer, whichever is longer.

Exclusions

Normal Wear and Tear. Periodic maintenance, repair and replacement of parts due to normal wear and tear are excluded from coverage.

Abuse & Misuse. Defects or damage that result from: (a) improper operation, storage, misuse or abuse, accident or neglect, such as physical damage (cracks, scratches, etc.) to the surface of the product resulting from misuse; (b) contact with liquid, water, rain, extreme humidity or heavy perspiration, sand,

dirt or the like, extreme heat, or food; (c) use of the Products or Accessories for commercial purposes or subjecting the Product or Accessory to abnormal usage or conditions; or (d) other acts which are not the fault of Motorola or MZGW are excluded from coverage.

Use of Non-Motorola branded Products and Accessories. Defects or damage that result from the use of Non-Motorola branded or certified Products or Accessories or other peripheral equipment are excluded from coverage.

Unauthorized Service or Modification. Defects or damages resulting from service, testing, adjustment, installation, maintenance, alteration, or modification in any way by someone other than Motorola, MZGW or its authorized service centers, are excluded from coverage.

Altered Products. Products or Accessories with (a) serial numbers or date tags that have been removed, altered or obliterated; (b) broken seals or that show evidence of tampering; (c) mismatched board serial numbers; or (d) nonconforming or non-Motorola branded housings, or parts, are excluded from coverage.

Communication Services. Defects, damages, or the failure of Products or Accessories due to any communication service or signal you may subscribe to or use with the Products or Accessories is excluded from coverage.

How to Obtain Warranty Service or Other Information?

To obtain service or information, please visit us at:
motorolanursery.com/support

You will receive instructions on how to ship the Products or Accessories at your expense and risk, to a MZGW Authorized Repair Center.

To obtain service, you must include: (a) the Product or Accessory; (b) the original proof of purchase (receipt) which includes the date, place and seller of the Product; (c) if a warranty card was included in your box, a completed warranty card showing the serial number of the Product; (d) a written description of the problem; and, most importantly; (e) your address and telephone number.

These terms and conditions constitute the complete warranty agreement between you and MZGW regarding the Products or Accessories purchased by you, and supersede any prior agreement or representations, including representations made in any literature publications or promotional materials issued by MZGW or representations made by any agent, employee or staff of MZGW, that may have been made in connection with the said purchase.

EU Declaration of Conformity (DoC)

Hereby, MZGW declares that the radio equipment type is in compliance with RE Directive 2014/53/EU. The full text of the EU declaration of conformity is available on the website: motorolanursery.com

FCC and IC regulations

FCC Caution:

Any changes or modifications not expressly approved by the party responsible for compliance could void the user's authority to operate the equipment.

This device complies with part 15 of the FCC Rules. Operation is subject to the following two conditions:

1. this device may not cause harmful interference, and
2. this device must accept any interference received, including interference that may cause undesired operation.

Important note:

This equipment has been tested and found to comply with the limits for a Class B digital device, pursuant to part 15 of the FCC Rules. These limits are designed to provide reasonable protection against harmful interference in a residential installation. This equipment generates, uses and can radiate radio frequency energy and, if not installed and used in accordance with the instructions, may cause harmful interference to radio communications. However, there is no guarantee that interference will not occur in a particular installation. If this equipment does cause harmful interference to radio or television reception, which can be determined by turning the equipment off and on, the user is encouraged to try to correct the interference by one or more of the following measures:

- Reorient or relocate the receiving antenna.
- Increase the separation between the equipment and receiver.
- Connect the equipment into an outlet on a circuit different from that to which the receiver is connected.
- Consult the dealer or an experienced radio/TV technician for help.

ISED/C Warning

This device complies with Innovation, Science, and Economic Development Canada licence-exempt RSS standard(s). Operation is subject to the following two conditions:

1. this device may not cause interference, and
2. this device must accept any interference, including interference that may cause undesired operation of the device.

Le présent appareil est conforme aux CNR d'Innovation, Sciences et Développement économique Canada applicables aux appareils radio exempts de licence. L'exploitation est autorisée aux deux conditions suivantes :

1. l'appareil n' doit pas produire de brouillage, et
2. l'utilisateur de l'appareil doit accepter tout brouillage radioélectrique subi, même si le brouillage est susceptible d'en compromettre le fonctionnement.

Radiation Exposure Statement:

The baby unit complies with FCC/ISED radiation exposure limits set forth for an uncontrolled environment. The baby unit should be installed and operated with minimum distance 20cm between the radiator& your body. For face up operation, please hold the device 10mm from your face.

The parent unit has been tested and comply with FCC and ISED SAR limits.

Déclaration d'exposition aux radiations:

L'unité bébé est conforme aux limites d'exposition aux rayonnements FCC / ISED établies pour un environnement non contrôlé. L'unité bébé doit être installée et utilisée avec une distance minimale de 20 cm entre le radiateur et votre corps. Pour un fonctionnement face vers le haut, tenez l'appareil à 10 mm de votre visage.

L'unité parent a été testée et est conforme aux limites SAR FCC et ISED.

Manufactured, distributed or sold by Meizhou Guo Wei Electronics Co. LTD., official licensee for this product. MOTOROLA and the Stylized M Logo are trademarks or registered trademarks of Motorola Trademark Holdings, LLC. and are used under license. All other trademarks are the property of their respective owners. © 2022 Motorola Mobility LLC. All rights reserved.

Version 5 (EN_EU&NA)

