

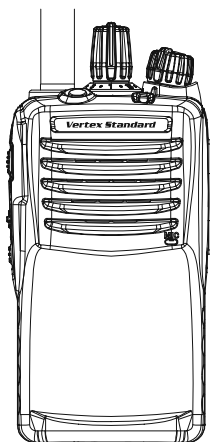

VX-450 SERIES

OPERATING MANUAL



VX-451

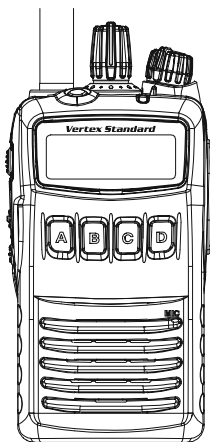

VX-454

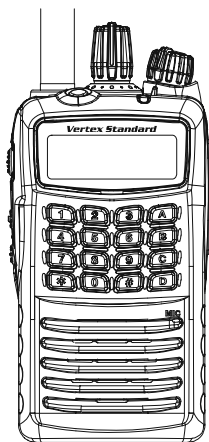

VX-459

PROGRAMMABLE FUNCTIONS/FEATURES

- IP57 Submersible (1 m/30 min.)
- Programmable Function Keys
- 2-tone Encode/Decode
- 5-tone Encode/Decode
- MDC-1200® Encode/Decode
- Scan
- Group Scan
- Dual Watch
- FM-Scan (Follow-Me Scan)
- TA Scan
- Encryption
- Clear Voice
- VOX
- REC & PLAY (Requires **DVS-8** or **DVS-9**)
- AF Min Volume
- Talk Around
- Man Down (Requires **DVS-9**)
- Emergency
- Lone Worker
- Direct Channel Entry*¹
- Code Up/Down*¹
- Code Set*¹
- Speed Dial*¹
- DTMF Code Set*²
- ID Check*¹
- TX Save Disable
- ARTS (Auto Range Transpond System)

*¹: VX-454 & VX-459 ONLY

*²: VX-459 ONLY

CONTENTS

Introduction	1	Operation	12
Warning! FCC RF Exposure Requirements	2	Preliminary Steps	12
Controls & Connectors (VX-459)	4	Operation Quick Start	12
Controls & Connectors (VX-454)	5	Advanced Operation	15
Controls & Connectors (VX-451)	6	Programmable Key Functions	15
LCD Icons & Indicators (VX-454 & VX-459)	7	Description of Operating Functions	18
Before You Begin	8	LOCK	30
Battery Pack Installation and Removal	8	Man Down Function	31
Low Battery Indication	8	ARTS (Auto Range Transpond System)	31
Battery Charging	8	User Set Mode	32
Belt Clip Installation and Removal	10	Optional Accessories	33
		Warranty Policy	34

CONGRATULATIONS!

You now have at your fingertips a valuable communications tool—a Vertex Standard two-way radio! Rugged, reliable and easy to use, your Vertex Standard radio will keep you in constant touch with your colleagues for years to come, with negligible maintenance down-time. Please take a few minutes to read this manual carefully. The information presented here will allow you to derive maximum performance from your radio, in case questions arise later on.

We're glad you joined the Vertex Standard team. Call on us anytime, because communications is our business. Let us help you get your message across.

Notice!: There are no owner-serviceable parts inside the radio. All service jobs must be referred to an authorized Vertex Standard Service Representative. Consult your Authorized Vertex Standard Dealer for installation of optional accessories.

INTRODUCTION

The **VX-450** Series are full-featured hand-held FM transceivers designed for business communications in the VHF or UHF Land Mobile bands. These transceivers are designed for reliable business communications in a wide variety of applications with a wide range of operating capability provided by their leading-edge design.

The **VX-451** allows to 32-channel capacity and 2 groups. The **VX-454/-459** allows to 512-channel capacity and 32 groups which can each be programmed with an 8-character Alpha-Numeric Tag.

Important channel frequency data is stored in EEPROM and flash memory on the CPU, and is easily programmable by Vertex Standard dealers using a personal computer and the Vertex Standard Programming Cable and **CE115** Software.

The pages which follow will detail the many advanced features provided in the **VX-450** Series transceiver. After reading this manual, you may wish to consult with your Network Administrator regarding precise details of the configuration of this equipment for use in your application.

IMPORTANT NOTICE FOR NORTH AMERICAN USERS REGARDING 406 MHz GUARD BAND

The U.S. Coast Guard and National Oceanographic and Atmospheric Administration have requested the cooperation of the U.S. Federal Communications Commission in preserving the integrity of the protected frequency range 406.0 to 406.1 MHz, which is reserved for use by distress beacons. Do not attempt to program this apparatus, under any circumstances, for operation in the frequency range 406.0 - 406.1 MHz if the apparatus is to be used in or near North America.

Warning - Frequency band 406 - 406.1 MHz is reserved for use ONLY as a distress beacon by the US Coast Guard and NOAA. Under no circumstance should this frequency band be part of the preprogrammed operating frequencies of this radio.

WARNING! FCC RF EXPOSURE REQUIREMENTS

This Radio has been tested and complies with the Federal Communications Commission (FCC) RF exposure limits for Occupational Use/Controlled exposure environment. In addition, it complies with the following Standards and Guidelines:

- FCC 96-326, Guidelines for Evaluating the Environmental Effects of Radio-Frequency Radiation.
- FCC OET Bulletin 65 Edition 97-01 (2001) Supplement C, Evaluating Compliance with FCC Guidelines for Human Exposure to Radio Frequency Electromagnetic Fields.
- ANSI/IEEE C95.1-1992, IEEE Standard for Safety Levels with Respect to Human Exposure to Radio Frequency Electromagnetic Fields, 3 kHz to 300 GHz.
- ANSI/IEEE C95.3-1992, IEEE Recommended Practice for the Measurement of Potentially Hazardous Electromagnetic Fields - RF and Microwave.

WARNING:

This radio generates RF electromagnetic energy during transmit mode. This radio is designed for and classified as *Occupational Use Only*, meaning it must be used only during the course of employment by individuals aware of the hazards, and the ways to minimize such hazards. This radio is not intended for use by the General Population in an uncontrolled environment.

CAUTION:

To ensure that your exposure to RF electromagnetic energy is within the FCC allowable limits for occupational use, always adhere to the following guidelines:

- This radio is NOT approved for use by the general population in an uncontrolled exposure environment. This radio is restricted to occupational use, work related operations only where the radio operator must have the knowledge to control his or her RF exposure conditions.**
- When transmitting, hold the radio in a vertical position with its microphone 2 inches (5 cm) away from your mouth and keep the antenna at least 2 inches (5 cm) away from your head and body.**

WARNING! FCC RF EXPOSURE REQUIREMENTS

- **The radio must be used with a maximum operating duty cycle not exceeding 50%, in typical Push-to-Talk configurations.**
DO NOT transmit for more than 50% of total radio use time (50% duty cycle). Transmitting more than 50% of the time can cause FCC RF exposure compliance requirements to be exceeded.
The radio is transmitting when the red LED on the top of the radio is illuminated. You can cause the radio to transmit by pressing the P-T-T button.
- **SAR compliance for body-worn use was only demonstrated for the specific belt-clip (CLIP-20). Other body-worn accessories or configurations may NOT comply with the FCC RF exposure requirements and should be avoided.**
- **DO NOT transmit when the radio is used in Body Worn configuration with the following accessory: belt-clip.**
It must be used ONLY for (1) there is 4 cm distance from the body during transmitting, (2) monitoring purposes, using the speaker only and (3) for carrying purposes.
- **Always use Vertex Standard authorized accessories.**
- **The information listed above provides the user with the information needed to make him or her aware of RF exposure, and what to do to assure that this radio operates with the FCC RF exposure limits of this radio.**
- **Electromagnetic Interference/Compatibility**
During transmissions, this radio generates RF energy that can possibly cause interference with other devices or systems. To avoid such interference, turn off the radio in areas where signs are posted to do so. Do not operate the transmitter in areas that are sensitive to electromagnetic radiation such as hospitals, health care facilities, aircraft, and blasting sites.

CONTROLS & CONNECTORS (VX-459)

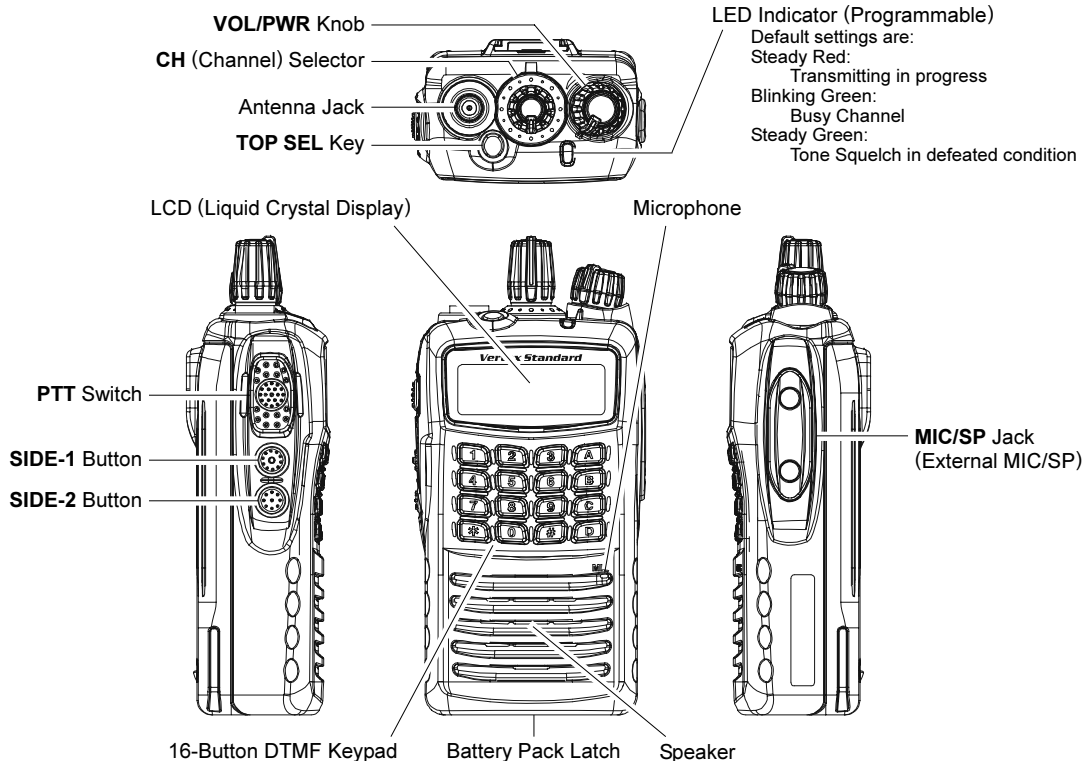

CONTROLS & CONNECTORS (VX-454)

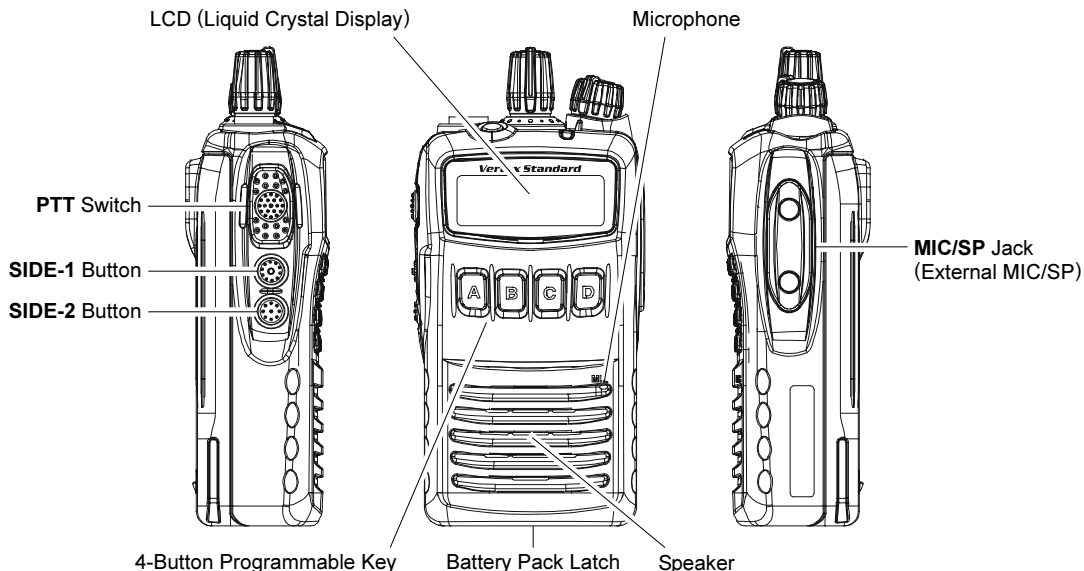
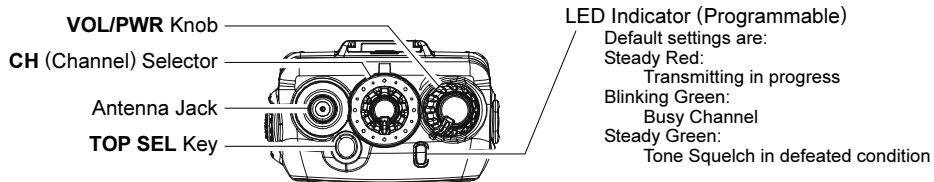

CONTROLS & CONNECTORS (VX-451)

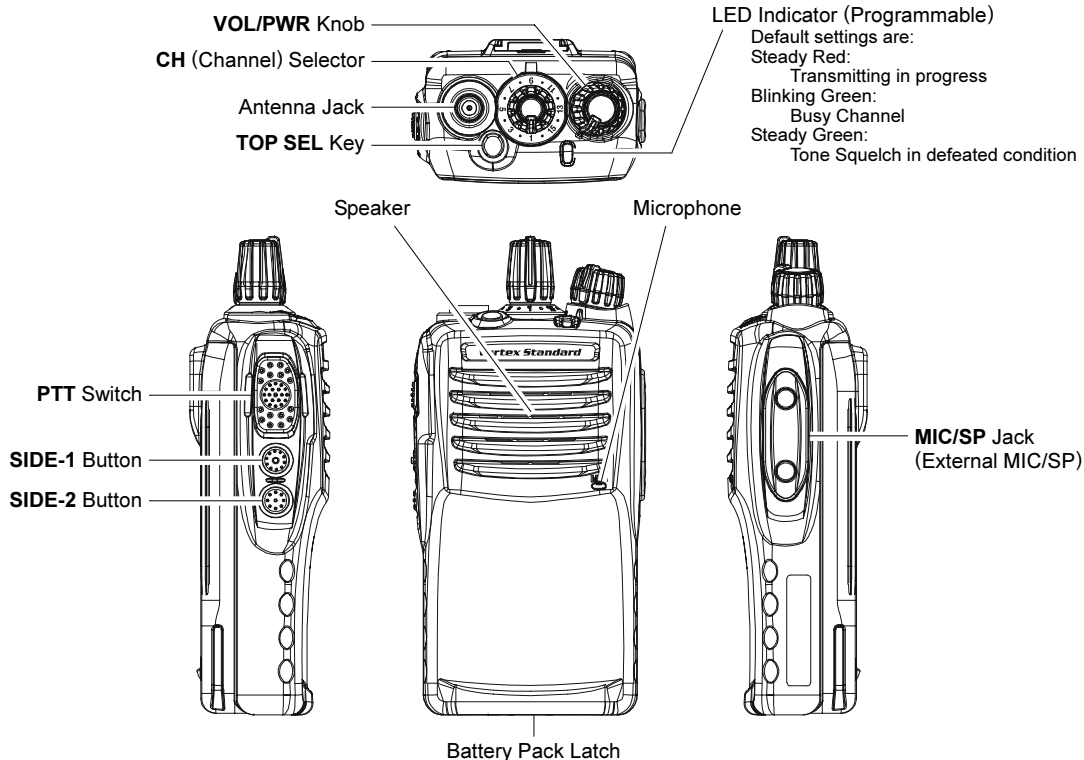

LCD ICONS & INDICATORS (VX-454 & VX-459)

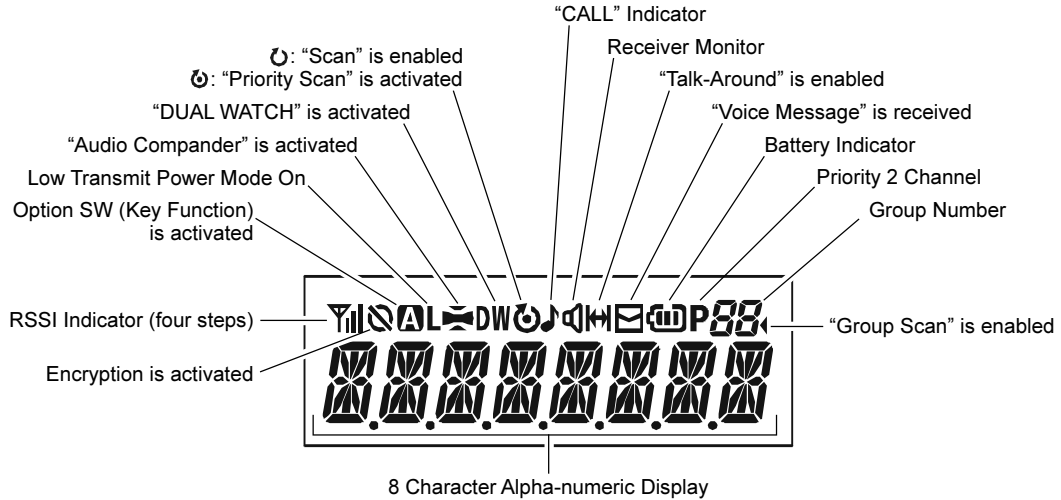

BEFORE YOU BEGIN

Battery Pack Installation and Removal

- To install the battery pack, align the battery pack to the radio with an offset about 1/2 inch from the top edge of battery compartment, then slide the battery pack upward until it locks in place with a “Click.”

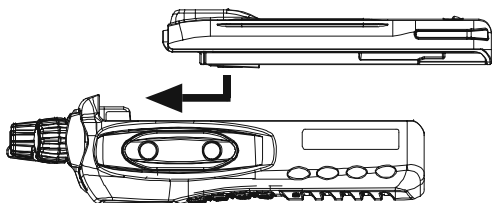

- To remove the battery, turn the radio off and remove any protective cases. Slide the Battery Pack Latch on the bottom of the radio toward the front panel while sliding the battery down about 1/2 inch. Then lift the battery out from the radio.

 **Do not attempt to open any of the rechargeable Lithium-Ion packs, as they could explode if accidentally short-circuited.**

Low Battery Indication

As the battery discharges during use, the voltage gradually becomes lower. When the battery voltage becomes to low, substitute a freshly charged battery and recharge the depleted pack. The LED indicator on the top of the radio will blink red when the battery voltage is low.

Caution

Danger of explosion if battery is replaced with an incorrect battery. Replace only with the same or equivalent type.

Battery Charging

- Referring to Figure 1, adjust the direction of the Battery Holder of the **CD-49** Desktop Charger in accordance with the battery pack being charged; Push in both sides of the Battery Holder while pulling up on the Battery Holder to remove it from the charger base, select the correct direction of the Battery Holder for the battery being charged, then

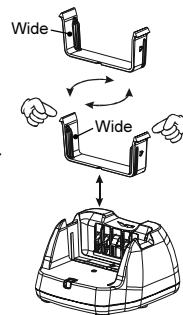

FIGURE 1

BEFORE YOU BEGIN

replace the Battery Holder by pressing down on both sides of the Battery Holder, if necessary.

- ❑ Referring to Figure 2, insert the DC plug from the optional **PA-45** AC Adapter into the DC jack on the rear panel of the **CD-49** Desktop Charger, and then plug the **PA-45** AC Adapter into the AC line outlet.
- ❑ Insert the battery pack into the **CD-49** Desktop Charger while aligning the slots of the battery pack with the guides in the nest of the **CD-49**; refer to the illustration at the right for details on proper positioning of the battery pack. If charging with the transceiver attached, turn the transceiver off. The antenna jack should be at the left side when viewing the charger from the front.
- ❑ If the battery pack is inserted correctly, the LED indicator will glow red. A fully-discharged battery pack will charge completely in 1.5 - 3.0 hours (depending on the battery pack being charged).
- ❑ When charging is completed, the LED indicator will change to green.
- ❑ Disconnect the battery pack from the **CD-49** Desktop Charger and unplug the **PA-45** AC Adapter from the AC line outlet.



1) Always use the Vertex Standard Co., Ltd. Model FNB-V112LI or FNB-V113LI Lithium-Ion Battery Pack.

2) Battery Pack shall not be exposed to excessive heat such as sunshine, fire, or the like.

3) Risk of explosion if battery is replaced by an incorrect type. Dispose of used batteries according to the instructions

4) Perform the battery charging where the ambient temperature range +5 °C to +35 °C. Charge out of this range could cause damage to the battery pack.

5) Use only the Vertex Standard Co., Ltd. Model PA-45 AC Adapter.

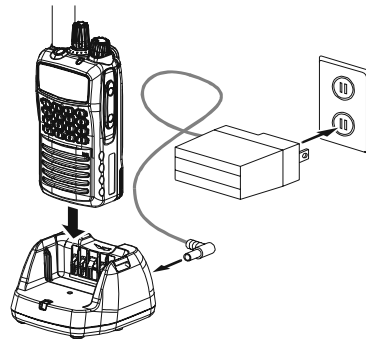
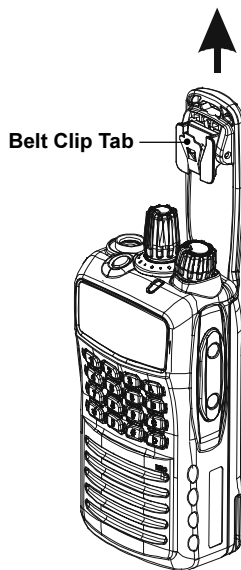
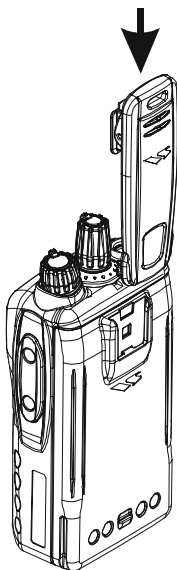

FIGURE 2

BEFORE YOU BEGIN

Belt Clip Installation and Removal

- ❑ To install the Belt Clip: align the Belt Clip to the groove of the Battery pack, then press the Belt Clip downward until it locks in place with a “Click.”
- ❑ To remove the Belt Clip: use a flat head screw driver to press the Belt Clip Tab away from the battery pack to unlock the Belt Clip, then slide the Belt Clip upward to remove it.



NOTE

OPERATION

Preliminary Steps

- Install a charged battery pack onto the transceiver, as described previously.
- Screw the supplied antenna onto the Antenna jack. Never attempt to operate this transceiver without an antenna connected.
- If you have a Speaker/Microphone, we recommend that it not be connected until you are familiar with the basic operation of the **VX-450** Series.

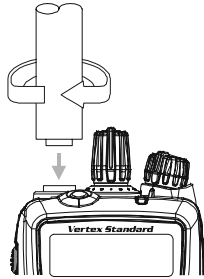

IMPORTANT NOTE

Water resistance of the transceiver (IP57: 1 meter / 30 minutes) is assured only when the following conditions:

- Battery pack is attached to the transceiver;
- Antenna is connected to the antenna jack;
- and **MIC/SP** cap is installed in the **MIC/SP** jack.

Operation Quick Start

- Turn the top panel's **VOL/PWR** knob clockwise to turn the radio on.

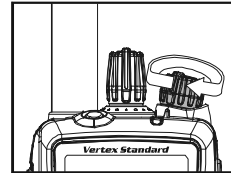

- Turn the top panel's **CH** Selector knob to choose the desired operating channel. On the **VX-454** and **VX-459**, a channel name will appear on the LCD.

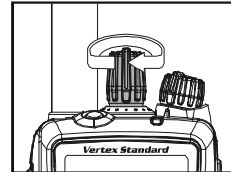

- If you want to select the operating channel from a different Channel Group, press the Programmable key (assigned to the Group Up or Down function) to select the Channel Group you want before selecting the operating channel. A Group name will appear on the LCD whenever the Programmable key is pressed.

Note: Some models are programmed so that the operating channels are selected by the Programmable key and the Channel Group is selected by the **CH** selector knob. For further details, contact your Vertex Standard dealer.

OPERATION

- ❑ Rotate the **VOL/PWR** knob to set the volume level. If no signal is present, press and hold in the **SIDE-1** button (under the **PTT** switch) more than 2 seconds; background noise will now be heard, and you may use this to set the **VOL/PWR** knob for the desired audio level. Press and hold the **SIDE-1** button more than 2 seconds (or press the **SIDE-1** button *twice*) to quiet the noise and resume normal (quiet) monitoring.

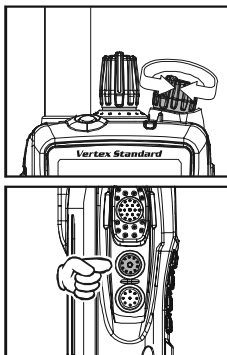

- ❑ To transmit, monitor the channel and make sure it is clear. Press and hold the **PTT** switch. Speak into the microphone area of the front panel grille in a normal voice level. To return to the Receive mode, release the **PTT** switch.
- ❑ Press the (Orange) **TOP SEL** key to activate one of the preprogrammed functions which may have been enabled at the time of programming by the dealer. See the next section for details regarding the available features.

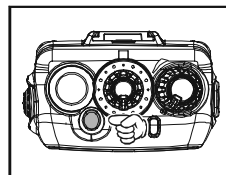
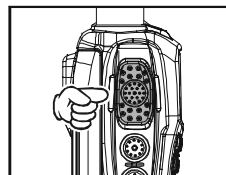

The Channel Announcement Feature works as described below

- (1) In the **VX-454/459** radio:
The maximum number of channels is 512 (32 channels maximum per group). The radio announces the channel number digit by digit.
For example, “Channel 1” is announced as “one” and “Channel 10” is announced as “one zero”.
- (2) In the **VX-451** radio:
The maximum number of channels is 32 (16 channels maximum per group). The radio announces Channels 1 - 9 by digit, while Channels 10 - 16 are announced by number.
For example, “Channel 10” is announced as “ten” and so on.

OPERATION

- ❑ If a Speaker/Microphone is available, remove the plastic cap and its two mounting screws from the right side of the transceiver, then align the connector of the Speaker/Microphone on the transceiver body; secure the connector pin using the screws supplied with the Speaker/Microphone. Hold the speaker grille up next to your ear while receiving. To transmit, press the **PTT** switch on the Speaker/Microphone, just as you would on the main transceiver's body, and speak into the microphone on a normal voice level.
Note 1): Save the original plastic cap and its mounting screws. They should be reinstalled when not using the Speaker/Microphone.
2) When you press the PTT switch on the Speaker/Microphone, it disables the internal microphone, and vice versa.

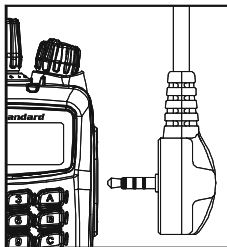

- ❑ If the Busy Channel Lockout feature has been programmed on a channel, the radio will not transmit when a carrier is present. Instead, the radio will generate short beep three times and indicate “CH BUSY” on the display (**VX-454** and **VX-459**). Release the **PTT** switch and wait for the channel to be clear of activity.
- ❑ If CTCSS or Digital Coded Squelch (DCS) Lockout has been programmed on a channel, the radio can transmit only when there is no carrier being received or when the carrier being received includes the correct CTCSS tone or DCS code.

Automatic Time-Out Timer

If the selected channel has been programmed for automatic time-out, you must limit the length of each transmission. While transmitting, a beep will sound 10 seconds before time-out. Another beep will sound just before the deadline; the “TX” indicator will disappear and transmission will cease soon thereafter. To resume transmitting, you must release the **PTT** switch and wait for the “penalty timer” to expire.

ADVANCED OPERATION

Programmable Key Functions

All versions of the **VX-450** include the **TOP SEL**, **SIDE-1**, and **SIDE-2** key. The **VX-454** and **VX-459** include the **[A]**, **[B]**, **[C]**, and **[D]** function keys. Furthermore, the **VX-459** includes the **[*]** and **[#]** function keys.

The Programmable key functions can be customized, via programming by your Vertex Standard dealer, to meet your communications/network requirements.

Some features may require the purchase and installation of optional internal accessories. The possible Programmable key programming features are illustrated on the next page, and their functions are explained beginning after page 18. For further details, contact your Vertex Standard dealer.

For future reference, check the box next to each function that has been assigned to the Programmable key on your particular radio, and keep it handy.

ADVANCED OPERATION

FUNCTION	PROGRAMMABLE KEY (PRESS KEY / PRESS AND HOLD KEY)								
	TOP SEL	SIDE-1	SIDE-2	[A] ^{*1}	[B] ^{*1}	[C] ^{*1}	[D] ^{*1}	[*] ^{*2}	[#] ^{*2}
None	/	/	/	/	/	/	/	/	/
Monitor	/	/	/	/	/	/	/	/	/
Monitor -Momentarily-Lamp ^{*1}	/-	/-	/-	/-	/-	/-	/-	/-	/-
Low Power	/	/	/	/	/	/	/	/	/
Encryption	/	/	/	/	/	/	/	/	/
Set ^{*1}	/	/	/	/	/	/	/	/	/
SQL OFF	/	/	/	/	/	/	/	/	/
SQL OFF -Momentarily-	/-	/-	/-	/-	/-	/-	/-	/-	/-
SQL Set ^{*1}	/	/	/	/	/	/	/	/	/
Beep Off	/	/	/	/	/	/	/	/	/
Whisper	/	/	/	/	/	/	/	/	/
VOX	/	/	/	/	/	/	/	/	/
VOX Set ^{*1}	/	/	/	/	/	/	/	/	/
Clear Voice	/	/	/	/	/	/	/	/	/
AF Min Volume	/	/	/	/	/	/	/	/	/
Emergency	/-	/-	/-	/-	/-	/-	/-	/-	/-
CH Announcement	/	/	/	/	/	/	/	/	/
VOX Anti-Trip	/	/	/	/	/	/	/	/	/
Lone Worker	/	/	/	/	/	/	/	/	/
Group Up ^{*1}	/	/	/	/	/	/	/	/	/
Group Down ^{*1}	/	/	/	/	/	/	/	/	/
Channel Up ^{*1}	/	/	/	/	/	/	/	/	/
Channel Down ^{*1}	/	/	/	/	/	/	/	/	/
Speed Channel Up ^{*1}	-/	-/	-/	-/	-/	-/	-/	-/	-/
Speed Channel Down ^{*1}	-/	-/	-/	-/	-/	-/	-/	-/	-/
PRI-1	/	/	/	/	/	/	/	/	/
PRI-2	/	/	/	/	/	/	/	/	/
PRI-2 Set	/	/	/	/	/	/	/	/	/
PRI-2 Disable	/	/	/	/	/	/	/	/	/
Direct Channel 1 ^{*1}	/	/	/	/	/	/	/	/	/
Direct Channel 2 ^{*1}	/	/	/	/	/	/	/	/	/
Direct Channel 3 ^{*1}	/	/	/	/	/	/	/	/	/
Direct Channel 4 ^{*1}	/	/	/	/	/	/	/	/	/
Direct Channel Entry ^{*2}	/	/	/	/	/	/	/	/	/

ADVANCED OPERATION

FUNCTION	PROGRAMMABLE KEY (PRESS KEY / PRESS AND HOLD KEY)								
	TOP SEL	SIDE-1	SIDE-2	[A] ^{*1}	[B] ^{*1}	[C] ^{*1}	[D] ^{*1}	[*] ^{*2}	[#] ^{*2}
Scan	/	/	/	/	/	/	/	/	/
Group Scan	/	/	/	/	/	/	/	/	/
Dual Watch	/	/	/	/	/	/	/	/	/
FM Scan	/	/	/	/	/	/	/	/	/
Scan Set ^{*1}	/	/	/	/	/	/	/	/	/
Group Scan Set ^{*1}	/	/	/	/	/	/	/	/	/
TA Scan	/	/	/	/	/	/	/	/	/
Talk Around	/	/	/	/	/	/	/	/	/
Reset	/	/	/	/	/	/	/	/	/
Call 1	/	/	/	/	/	/	/	/	/
Call 2	/	/	/	/	/	/	/	/	/
Call 3	/	/	/	/	/	/	/	/	/
Call 4	/	/	/	/	/	/	/	/	/
Call 5	/	/	/	/	/	/	/	/	/
Code Up ^{*1}	/	/	/	/	/	/	/	/	/
Code Down ^{*1}	/	/	/	/	/	/	/	/	/
Code Set ^{*1}	/	/	/	/	/	/	/	/	/
Speed Dial ^{*1}	/	/	/	/	/	/	/	/	/
DTMF Code Set ^{*2}	/	/	/	/	/	/	/	/	/
Call	/	/	/	/	/	/	/	/	/
Status Set ^{*1}	/	/	/	/	/	/	/	/	/
Status Up ^{*1}	/	/	/	/	/	/	/	/	/
Status Down ^{*1}	/	/	/	/	/	/	/	/	/
Status Check ^{*1}	/	/	/	/	/	/	/	/	/
Duty	/	/	/	/	/	/	/	/	/
ID Check ^{*1}	/	/	/	/	/	/	/	/	/
ARTS Login ^{*1}	/	/	/	/	/	/	/	/	/
Option Switch 1	/-	/-	/-	/-	/-	/-	/-	/-	/-
Option Switch 2	/	/	/	/	/	/	/	/	/
REC ^{*3}	/	/	/	/	/	/	/	/	/
PLAY ^{*3}	/	/	/	/	/	/	/	/	/
TX Save Disable	/	/	/	/	/	/	/	/	/
Lock	/	/	/	/	/	/	/	/	/

※1: VX-454 and VX-459 only. ※2: VX-459 only. ※3: DVS-8 or DVS-9 is required.

ADVANCED OPERATION

Description of Operating Functions

MONITOR

Press (or press and hold) the assigned Programmable key to cancel any signaling features; the **BUSY/TX** indicator will glow green.

MONITOR -MOMENTARILY-

Cancel any signaling features while pressing the assigned programmable key.

LAMP (VX-454 AND VX-459 ONLY)

Press (or press and hold) the assigned Programmable key to illuminate the display for five seconds.

LOW POWER

Press (or press and hold) the assigned Programmable key to set the radio's transmitter to the "Low Power" mode, thus extending battery life. Press (or press and hold) the key again to return to "Normal" transmit power when in difficult terrain.

In the **VX-454/-459**, when the radio's transmitter is set to "Low Power" mode, the "L" icon will be indicated on the display.

ENCRYPTION

Press (or press and hold) the assigned Programmable key to toggle the Encryption feature "On" and "Off."

In the **VX-454/-459**, when the Voice Scrambler feature is activated, the "🔒" icon will be indicated on the display.

SET (VX-454 AND VX-459 ONLY)

Press (or press and hold) the assigned Programmable key to activate the "User Set" (Menu) Mode. See "User Set Mode" chapter for details.

SQL OFF

Press (or press and hold) the assigned programmable key to open the SQL to hear background noise (unmute the audio).

SQL OFF -MOMENTARILY-

Opens the SQL to hear background noise (unmute the audio) while pressing the assigned programmable key.

ADVANCED OPERATION

SQL SET (VX-454 AND VX-459 ONLY)

You can manually adjust the squelch level using this function:

- Press (or press and hold) the assigned Programmable key. A tone will sound, and the current squelch level will appear on the display.
- Press the **SIDE-1/SIDE-2** button or **[A]/[B]** button to select the desired squelch level.
- Press the **[D]** key to store the new setting. The display indicates “- SET -” briefly, then reverts to the normal channel indication.

You may cancel the new setting by pressing the **[C]** key. In this case, the display indicates “- CANCEL -” briefly.

BEEP OFF

Press (or press and hold) the assigned Programmable key to disable the radio beeps temporarily. Again press (or press and hold) the assigned Programmable key to enable the radio beeps.

WHISPER

Press (or press and hold) the assigned Programmable key to increase the microphone gain; thus you can speak in a low voice (whisper) temporarily. Again press (or press and hold) the assigned Programmable key to resume normal microphone gain.

VOX

Press (or press and hold) the assigned programmable key to turn the VOX function “On” or “Off”. You may disable the VOX function temporarily by pressing the **PTT** switch.

ADVANCED OPERATION

VOX SET (VX-454 AND VX-459 ONLY)

You can manually adjust the VOX Gain using this function:

- ❑ Press (or press and hold) the assigned programmable key. A tone will sound, and the current VOX Gain level will appear on the display.
- ❑ Press the [A]/[B] button to select the desired VOX Gain level.
- ❑ Press the [D] key to store the new setting. The display indicates “- SET -” briefly, then reverts to the normal channel indication.

You may cancel the new setting by pressing the [C] key. In this case, the display indicates “- CANCEL -” briefly.

CLEAR VOICE

Press (or press and hold) the assigned programmable key to activate the Clear Voice feature. When you are operating in a noisy environment, activate the Clear Voice feature. Again press (or press and hold) the assigned programmable key to disable the Clear Voice feature.

AF MIN VOLUME

Press (or press and hold) the assigned Programmable key to reduce the audio output to the (lower) level programmed by your Vertex Standard dealer.

CH ANNOUNCEMENT

Press (or press and hold) the assigned Programmable key to select the channel change confirmation between “beep” and “announcement”.

VOX ANTI-TRIP

Press (or press and hold) the assigned Programmable key to toggle the VOX Anti-Trip feature “On” and “Off”.

When the VOX Anti-Trip feature is set to “On”, the transceiver does not activate the transmitter section from the receiver audio and own beep sound.

In the **VX-454/-459**, when the VOX Anti-Trip feature is set to “On”, the display indicates “ATRP ON” briefly. When the VOX Anti-Trip feature is set to “Off”, the display indicates “ATRP OFF” briefly.

ADVANCED OPERATION

EMERGENCY

The **VX-450** series include an “Emergency” feature which may be useful for alerting another party monitoring on the same frequency as your transceiver’s channel.

Press the assigned Programmable key to initiate an emergency call. For further details contact your Vertex Standard dealer.

LONE WORKER

Press (or press and hold) the assigned Programmable key to toggle the Lone Worker feature “On” and “Off”.

The Lone Worker feature is designed to emit an alarm for 30 seconds when the Lone Worker Timer (programmed by your Vertex Standard dealer) has expired. If the user does not reset the timer by pressing the **PTT** switch, the radio switches to the Emergency mode.

GROUP UP/DOWN (VX-454 AND VX-459 ONLY)

Press (or press and hold) the assigned Programmable key to select a different Group of channels. Once the desired Group is reached, rotate the **CH** Selector knob to select the desired channel within the selected Group.

CHANNEL UP/DOWN (VX-454 AND VX-459 ONLY)

Press (or press and hold) the assigned Programmable key to select a different channel within the current Group.

SPEED CH UP/DOWN (VX-454 AND VX-459 ONLY)

Press and hold the assigned programmable key causes the radio to begin stepping (repeatedly) upward or downward through the channels.

PRI-1/PRI-2

Press (or press and hold) the assigned programmable key to recall the pre-programmed priority channel directly. This is pre-programmed by your Vertex Standard dealer.

ADVANCED OPERATION

PRI-2 SET

Press (or press and hold) the assigned programmable key to toggle the current channel to the priority channel 2 “enable” and “disable”.

PRI-2 DISABLE

Press (or press and hold) the assigned programmable key to disable the priority channel 2 of the group temporarily.

DIRECT CH1 TO CH4 (VX-454 AND VX-459 ONLY)

Press (or press and hold) the assigned Programmable key to recall the Dealer pre-programmed channel directly.

DIRECT CH ENTRY (VX-459 ONLY)

You can recall the desired channel directly using this function:

- Press (or press and hold) the assigned programmable key. A tone will sound, and the current group/channel number will appear on the display.
- Enter the desired group number (two digits) and channel number (two digits) by the keypad.
- Press the **[D]** key to store the new setting. The display indicates “- SET -” briefly, then reverts to the normal channel indication.

You may cancel the new setting by pressing the **[C]** key. In this case, the display indicates “- CANCEL -” briefly.

ADVANCED OPERATION

SCAN

The Scanning feature is used to monitor multiple signals programmed into the transceiver. While scanning, the transceiver will check each channel for the presence of a signal, and will stop on a channel if a signal is present.

To activate scanning:

- Press (or press and hold) the assigned Programmable key to activate scanning.
- The scanner will search the channels of each channel, looking for active ones; it will pause each time it finds a channel on which someone is speaking.
- Press (or press and hold) the assigned Programmable key again to disable scanning. Operation will revert to the programmed revert channel.

Note: Your dealer may have programmed your radio to stay on one of the following channels if you press the **PTT** switch during scanning pause:

- “Scan Pause” channel (“Talk Back”)
- “Last Busy” channel
- “Priority-1/-2” channel
- “User Programmed” channel (“Select Channel”)
- “Scan Start” channel

GROUP SCAN

The Scanning feature is used to monitor multiple channels programmed into the transceiver. While scanning, the transceiver will check each channel of the programmed group for the presence of the signal, and will stop on a channel if a signal is present.

Press (or press and hold) the assigned programmable key to activate the scanning on the selected groups.

DUAL WATCH

The Dual Watch feature is similar to the SCAN feature, except that only two channels are monitored:

- The current operating channel; and
- The Priority-1/-2 channel.

To activate Dual Watch:

- Press (or press and hold) the assigned Programmable key.
- The scanner will search the two channels; it will pause each time it finds a channel on which someone is speaking.

To stop Dual Watch:

- Press (or press and hold) the assigned Programmable key.
- Operation will revert to the “Dual Watch Revert” channel.

ADVANCED OPERATION



FM SCAN (FOLLOW-ME SCAN)

The FM Scan feature checks a User-assigned Priority Channel regularly as you scan other channels. Thus, if only Channels 1, 3, and 5 (of the 8 available channels) are designated for “Scanning,” the user may nonetheless assign Channel 2 as the “User-assigned” Priority Channel via the FM Scan.

To activate FM Scan, first select the channel you want to designate as the “User-Assigned Priority Channel” and press (or press and hold) the assigned programmable key. Then rotate the **CH** Selector knob to recall to the “Scanning Start” channel which has been programmed by your dealer to activate the scanner. When the scanner stops on an “Active” channel, the User-assigned Priority Channel will automatically be checked every few seconds; if activity is found on the User-assigned Priority Channel, the radio will switch between it and the Dealer-Assigned Priority Channel, if any.



SCAN SET (VX-454 AND VX-459 ONLY)

Press (or press and hold) the assigned programmable key to add/delete the current channel to/from your scanning list.

When you delete channel, the display indicates “SCN SKIP” briefly and the “” icon will disappear from the display. To restore a particular channel to your scanning list, press (or press and hold) the assigned programmable key again; the display indicates “SCN SET ” briefly and “” icon will appear on the display.

Furthermore, press (or press and hold) the assigned programmable key while the scanner is paused, this removes the channel from the scan list temporarily.



GROUP SCAN SET (VX-454 AND VX-459 ONLY)

You may wish to have the Scanner pass through more than one Group during the scanning process (normally, scanning is performed within the current group only). To include the current Group in the scanning loop, press (or press and hold) the assigned programmable key (the “” icon will appear on the display). To remove a current Group from Group Scan, press (or press and hold) the assigned programmable key again (the “” icon will disappear from the display).

ADVANCED OPERATION

TA SCAN

Press (or press and hold) the assigned Programmable key to toggle the TA (Talk Around) scan feature “On” and “Off.”

While TA scan is proceeding, the transceiver will search both the transmit and receive frequencies (In the **VX-454/-459**, the “” icon will blink). When a signal is encountered on the receive frequency, the **VX-450** will pause until the signal disappears (“” icon will appear but not blink). When a signal is encountered on the transmit frequency, the transceiver will check for activity on the receive frequency every few seconds (interval programmed by your Ver-tex Standard dealer.).

Note: The TA Scan feature does not activate on the Simplex Channel.

TALK AROUND (TA)

Press (or press and hold) the assigned Programmable key to activate the Talk Around feature when you are operating on duplex channel systems (separate receive and transmit frequencies, utilizing a “repeater” station). The Talk Around feature allows you to bypass the repeater station and talk directly to a station that is nearby. This feature has no effect when you are operating on “simplex” channels, where the receive and transmit frequencies are already the same.

In the **VX-454/-459**, when the “TA” function is activated, the “” icon will be indicated on the display.

Note that your dealer may have mode provision for “Talk Around” channels by programming “repeater” and “Talk Around” frequencies on two adjacent channels. If so, the key may be used for one of the other Pre-Programmed Functions.

Note: The Talk Around feature does not activate on the Simplex Channel.

RESET

Press (or press and hold) the assigned programmable key to reset the RFC (Ready for Communication) condition.

ADVANCED OPERATION

CALL 1 TO CALL 5

Press (or press and hold) the assigned Programmable key to send a 2-tone/5-tone sequential tone group which is pre-defined.

CODE UP/DOWN (VX-454 AND VX-459 ONLY)

Press (or press and hold) the assigned Programmable key to select a 2-tone/5-tone encode code from the pre-defined encode list.

CODE SET (VX-454 AND VX-459 ONLY)

- Press (or press and hold) the assigned programmable key to change the 5-Tone encoding digit. To change the tones, select the desired digit using the [A]/[B] keys, then change the number using the **SIDE-1/SIDE-2** keys.
- Press the [D] key to store the new setting. The display indicates “- SET -” briefly, then reverts to the normal channel indication. You may cancel the new setting by pressing the [C] key. In this case, the display indicates “- CANCEL -” briefly.

In the **VX-459**, you may enter the 5-Tone encoding code directly from the 16-Button DTMF keypad ([0] - [9]) and [*] key (wild card).

SPEED DIAL (VX-454 AND VX-459 ONLY)

Your Dealer may have pre-programmed Auto-Dial telephone number memories into your radio.

To dial a number, press the [A]/[B] key to select the Auto-Dial memory number list provided by your Dealer or Network Administrator, then press the **PTT** switch. The DTMF tones sent during the dialing sequence will be heard in the speaker.

In the **VX-459**, press (or press and hold) the assigned Programmable key, then press the front panel's numeric key corresponding to the Auto-Dial memory number list provided by your Dealer or Network Administrator. The DTMF tones sent during the dialing sequence will be heard in the speaker.

DTMF CODE SET (VX-459 ONLY)

You may send the desired telephone number manually.

To dial a number manually, press (or press and hold) the assigned Programmable key, then press the desired numbers on the front panel's numeric key. Now, press the **PTT** switch to send the telephone number. The DTMF tones sent during the dialing sequence will be heard in the speaker.

ADVANCED OPERATION

CALL

When using the DTMF Paging System

This feature, if enabled, allows the user to change the 3-digit Page Call code, used to call other similarly-equipped stations. Press (or press and hold) the assigned programmable key, followed by the three digits representing the Page Call code of the station you wish to call. Three tones will be heard after the last key is pressed (the new code will now be transmitted).

The receiver squelch of the other station will be opened, and you can begin communication.

When using the 2-tone/5-tone Signaling System

This feature, if enabled, press (or press and hold) the assigned programmable key to send a 2-tone/5-tone sequential tone.

When using the MDC1200 System

This feature, if enabled, press (or press and hold) the assigned programmable key to send an MDC1200 code.

- Press (or press and hold) the assigned programmable key to enter the “Call Menu” mode.
- Press the **SIDE-1/SIDE-2** to select the desired Call mode, then press the **[D]** key to accept the selection. You may cancel the selection by pressing the **[C]** key.

- Press the **SIDE-1/SIDE-2** to select the station to be called.

You may enter the station’s ID number (four digits) directly from the 16-Button DTMF keypad (**[0]** - **[9]**, **[A]** - **[D]**, **[#]**: substitute for “E”, and **[*]**: wild card), if your transceiver is **VX-459**.

- Press the **PTT** switch to send an MDC1200 call.

STATUS SET (VX-454 AND VX-459 ONLY)

Press (or press and hold) the assigned Programmable key to change the 5-Tone status code. To change the status code, select the desired digit by **[A]** key, then change the number by **[B]/[C]** key, and store the number by **[D]** key.

STATUS UP/DOWN (VX-454 AND VX-459 ONLY)

Press (or press and hold) the assigned Programmable key to select a 5-Tone status code from the pre-defined status list.

ADVANCED OPERATION

STATUS CHECK (VX-454 AND VX-459 ONLY)

Press (or press and hold) the assigned Programmable key to check the 5-Tone receive status code. When you press (or press and hold) this key, the display will indicate the “Message” corresponding to the receive status condition per the pre-defined status list.

DUTY

Press (or press and hold) the assigned Programmable key to toggle the Duty function of the 2-tone/5-tone decoder “On” and “Off.”

When the Duty function is set to “On,” the user will always hear (depending on the sub-audio signalling) all traffic on the paging channel. The radio will sound the paging alert when it receives the programmed 2-tone/5-tone code.

When the Duty function is set to “Off,” the user will NOT hear normal radio traffic on the paging channel. The radio will sound the paging alert and unmute only when it receives the programmed 2-tone/5-tone code.

ID CHECK (VX-454 AND VX-459 ONLY)

This function allows logged ID of the DTMF Signaling and 5-tone Signaling to be reviewed and relayed (5-tone Signaling only) to a specific station:

- Press (or press and hold) the assigned programmable key to display the logged ID of the DTMF Signaling and 5-tone Signaling.
- Press the [**A**] key to select the category (“DTMF Signaling” or “5-tone Signaling”) to be reviewed, then press the **SIDE-1/SIDE-2** keys to select the ID.
- Press the [**B**] key to toggle the display between the “ID code display” and “Tag display”.
- Press the [**D**] key to send the Call back, when recalling the ID of the “5-tone Signaling”, if desired. You may cancel the Call back sending by pressing the [**C**] key. In this case, the display indicates “- CANCEL -” briefly.

ADVANCED OPERATION

ARTS LOGIN (VX-454 AND VX-459 ONLY)

This function enable the displaying the logged ID of the MDC1200 ARTS™ (ARTS™II).

- ❑ Press (or press and hold) the assigned programmable key to display the number of the logged station of the MDC1200 ARTS™ (ARTS™II).
- ❑ Press the **SIDE-1/SIDE-2** keys to display the ID.



OPTION SWITCH 1

Activates the optional accessory “1” while pressing the assigned Programmable key.

OPTION SWITCH 2

Press (or press and hold) the assigned Programmable key to toggle the optional accessory “2” “On” and “Off.”

REC (REQUIRES THE DVS-8 OR DVS-9)

Press (or press and hold) the assigned Programmable key to enable the Voice Recording Mode. If the incoming signal is received, so as to un-mute the squelch and pass audio, then the “” Icon will flash* and received audio will be recorded. When the voice recording is completed, the “” stays on*.

※: **VX-454** and **VX-459** Only.

PLAY (REQUIRES THE DVS-8 OR DVS-9)

Press (or press and hold) the assigned programmable key to play back the last message.

Press (or press and hold) the assigned programmable key again to stop the play-back.

While playback is proceeding, you may press the [**A**] key to jump to the previous message, or press the [**B**] key to jump to the next message. Furthermore, press the [**D**] key to delete all messages and stop the play-back.

TX SAVE DISABLE

Press (or press and hold) the assigned Programmable key to disable the Transmit Battery Saver, if you are operating in a location where high power is almost always needed.

The Transmit Battery Saver helps extend battery life by reducing transmit power when a very strong signal from an apparently nearby station is being received. Under some circumstances, though, your hand-held radio may not be heard well at the other end of the communication path, and high power may be necessary at all times.

ADVANCED OPERATION

Lock

Press (or press and hold) the assigned Programmable key to lock the **CH** Selector knob, Programmable keys, and **PTT** switch. The precise lockout configuration is programmed by your Vertex Standard Dealer.

LOCK

In order to prevent accidental channel change or inadvertent transmission, various aspects of the **CH** Selector knob, Programmable keys, and **PTT** switch may be locked.

The precise lockout configuration is programmed by your Dealer.

To locked out the key locking, turn the radio off. Now, press and hold the **PTT** and **SIDE-2** key while turning the radio on again.

To cancel locking, repeat this process.

MAN DOWN FUNCTION (REQUIRES THE DVS-9)

The man down function is programmable to monitor a variety of worker timed safety scenarios vertically and horizontally as well as worker degree of motion. For further details contact your Vertex Standard Dealer.

ARTS™ (AUTO RANGE TRANSPOND SYSTEM)

This system is designed to inform you when you and another ARTS™-equipped station are within communication range.

During ARTS™ operation, when the radio receives an incoming ARTS™ signal, a short beep will sound, and “IN SERV” (“In Service”) will be indicated on the display for 2 seconds*. If you move out of range for more than two minutes, your radio senses that no signal has been received; a short triple-beep will sound, and “OUT SERV” (“Out of Service”) will be displayed on the display for 2 seconds*. If you subsequently move back into communication range, as soon as the other station transmits, a short beep will sound and “IN SERV” will be indicated again on the display for 2 seconds*

※: VX-454 and VX-459 Only.

USER SET MODE

The **VX-454/-459** includes a “User Set (Menu)” Mode which allows the user to define or configure various settings, such as Beep On/Off, Squelch, etc. To activate the “User Set (Menu)” Mode:

- Press (or press and hold) the programmable key assigned to the “**SET**” function.
- Select the User Set Mode Item you wish to change using the **[A]/[B]** keys, then use the **[SIDE-1]/[SIDE-2]** button to adjust the setting of the selected item.
- Press the **[D]** key to store the new configuration. The display indicates “- SET -” briefly, then exits to normal operation.
You may cancel the selection by pressing the **[C]** key. The display indicates “- CANCEL -” briefly, then exits to normal operation.

Note: The menu “14: REC Mode” and “15: Play Mode” will appear only when the Voice Recording Unit is installed.

DISPLAY	DESCRIPTION
1 SQL	Select the Squelch Threshold Level (-15 to +15)
2 BEEP	Set the Beep ON / OFF
3 BELL	Set the Bell ON / OFF (Bell engaged by sub-audible CTCSS/DCS)
4 LIGHT	Set the BUSY/TX LED and Lamp ON / OFF
5 KEY	Set the Key Lock function ON (Lock) / OFF (Free)
6 DIAL	Set the DIAL Lock function ON (Lock) / OFF (Free)
7 PTT	Set the PTT Lock function ON (Lock) / OFF (Free)
8 SCAN	Set the Scan status OFF: Stop the Scan ON: Start the Scan GRP: Start the Group Scan FM: Start the Follow-Me Scan
9 DW	Set the Dual Watch ON / OFF (same function as DW key)
10 AF	Set the Minimum Volume level (000 to 255)
11 VOX	Set the VOX level (-2 to +2) (This menu will appear only when the VOX setting of the current channel is set to “Key ON” or “Power ON”.)
12 TX SV	Set the TX Saver ON / OFF
13 ENCR	Set the Encryption ON / OFF (This menu will appear only when the Encryption setting of the current channel is set to “Key ON” or “Power ON”.)
14 REC	Select the recording mode. ONE: Enables recording one message (max. 120 seconds), and playback from the beginning of the message. ROL: Enables recording whenever squelch opens, and playback of the last 120 seconds.
15 PLAY	Set the priority audio on playback mode. PLY: Playback audio is higher priority than received signal SIG: Received signal is higher priority than playback audio

OPTIONAL ACCESSORIES

FNB-V112LI	7.4V, 1170 mAh Li-Ion Battery Pack	LCC-450	Leather Case
FNB-V113LI	7.4V, 2400 mAh Li-Ion Battery Pack	CLIP-20	Belt Clip
CD-49	Desktop Charger	ATV-16A	VHF Antenna (136-150 MHz)
PA-45	AC Adapter	ATV-16B	VHF Antenna (150-162 MHz)
MH-360S	Compact Speaker Microphone	ATV-16C	VHF Antenna (162-174 MHz)
MH-450S	Speaker Microphone	ATV-16XL	VHF Antenna (Untuned)
MH-45B4B	Noise Cancelling Speaker Microphone	ATU-16B	UHF Antenna (400-420 MHz)
MH-37A4B	Earpiece Microphone	ATU-16C	UHF Antenna (420-450 MHz)
MH-66A4B	Submersible Speaker Microphone	ATU-16D	UHF Antenna (450-470 MHz)
MH-81A4B	Over-the-head VOX Compatible Headset	ATU-16F	UHF Antenna (470-520 MHz)
VC-25	Over-the-head VOX Headset	CN-2A	Antenna Adapter
VH-110S	Over-the-head, Heavy Duty Headset	CSS450	Channel Selector Stopper
VH-120S	Earpiece mic w/palm PTT Switch	CE115	PC Programming Software
VH-130S	Earpiece w/palm mic and PTT switch	FIF-10A	USB Programming Interface
VH-115S	Behind-the-head Headset w/boom mic	CT-106	Connection Cable for FIF-10A
VH-215S	Over-the-head single-muff Headset	CT-27	Radio to Radio Cloning Cable
DVS-8	Voice Storage Unit		
DVS-9	Man Down Alert with Digital Voice Storage Unit		

Availability of accessories may vary; some accessories are supplied standard per local requirements, others may be unavailable in some regions. Check with your VERTEX STANDARD Dealer for changes to this list.

WARRANTY POLICY

Vertex Standard warrants, to the original purchaser only, its Vertex Standard manufactured communications products against defects in materials and workmanship under normal use and service for a given period of time from the date of purchase.

Limited Warranty Details:

- North America customers (USA and Canada): <http://www.vertexstandard.com/lmr/warranty-terms.aspx>
- Customers outside of North America: contact the authorized dealer in your country.

NOTE

NOTE

Part 15.21: Changes or modifications to this device not expressly approved by Vertex Standard could void the user's authorization to operate this device.

เครื่องโทรคมนาคมและอุปกรณ์นี้ มีความสอดคล้องตามข้อกำหนดของ กทช.

DISPOSAL OF YOUR ELECTRONIC AND ELECTRIC EQUIPMENT

Products with the symbol (crossed-out wheeled bin) cannot be disposed as household waste.

Electronic and Electric Equipment should be recycled at a facility capable of handling these items and their waste byproducts.

In EU countries, please contact your local equipment supplier representative or service center for information about the waste collection system in your country.



ATTENTION IN CASE OF USE

This transceiver works on frequencies which are not generally permitted.

For frequency allocation, apply for a licence at your local spectrum management authority.

For actual usage contact your dealer or sales shop in order to get your transceiver adjusted to the allocated frequency range.

List of the practicable area

AUT	BEL	BGR	CYP	CZE	DEU	DNK	ESP	EST
FIN	FRA	GBR	GRC	HUN	IRL	ITA	LTU	LUX
LVA	MLT	NLD	POL	PRT	ROU	SVK	SVN	SWE
CHE	ISL	LIE	NOR					

 **Vertex Standard**



Declaration of Conformity

We, YAESU UK Ltd. declare under our sole responsibility that the following equipment complies with the essential requirements of the Directive 1999/5/EC.

Type of Equipment: FM Transceiver
Brand Name: VERTEX STANDARD
Model Number: VX-450 Series
Manufacturer: Vertex Standard Co., Ltd.
Address of Manufacturer: 4-8-8 Nakameguro Meguro-Ku, Tokyo
153-8644, Japan

Applicable Standards:

This equipment is tested and conforms to the essential requirements of directive, as included in following standards.

Radio Standard: EN 300 086-2 V1.3.1
EMC Standard: EN 301 489-01 V1.8.1
EN 301 489-05 V1.3.1
Safety Standard: EN 60950-1: 2006 +A1: 2010

The technical documentation as required by the Conformity Assessment procedures is kept at the following address:

Company: YAESU UK Ltd.
Address: Unit 12, Sun Valley Business Park, Winnall Close
Winchester, Hampshire, SO23 0LB, U.K.



Vertex Standard LMR, Inc.



E C 0 9 4 U 1 0 5

Copyright 2013
Vertex Standard LMR, Inc.
All rights reserved.

No portion of this manual
may be reproduced
without the permission of
Vertex Standard LMR, Inc.

Printed in China